



HO, HO, HO!

In dieser Nacht hat der Weihnachtsmann seinen großen Auftritt in dem gemütlichen kleinen Haus. Die Familie wartet schon auf seinen Besuch! Die Weihnachtskarten wurden aus dem Briefkasten geholt, der Tisch ist gedeckt, die Geschenke wurden eingepackt und ein Teller mit Plätzchen und Milch wurde dem Weihnachtsmann hingestellt. Jetzt muss er nur noch den Schornstein herunterrutschen und echte Weihnachtsfreude versprühen!





Chris McVeigh
LEGO® Designer

ANMERKUNGEN DES DESIGNTEAMS

Das ist schon das zweite Set aus der Winter-Sammlung, das der LEGO® Designer Chris McVeigh entworfen hat. Chris ist also auf dem besten Weg, der Weihnachtsexperte im Designteam zu werden: „Die Weihnachtstage sind immer eine magische Zeit für meine Familie. Es hat Spaß gemacht, meine eigenen Familientraditionen und Erfahrungen wie das neue Weihnachtsplätzchen und die versteckten Geschenke in dieses Set einfließen zu lassen.“

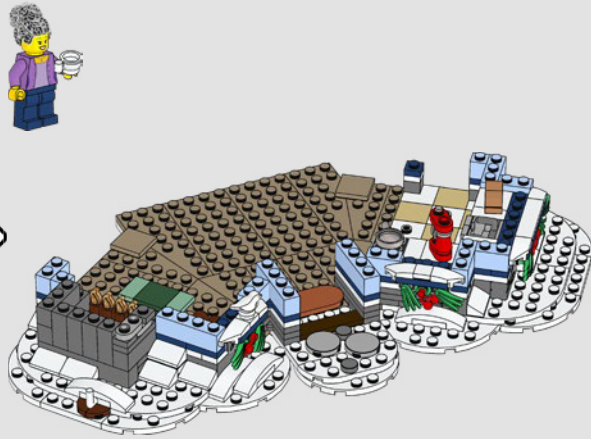

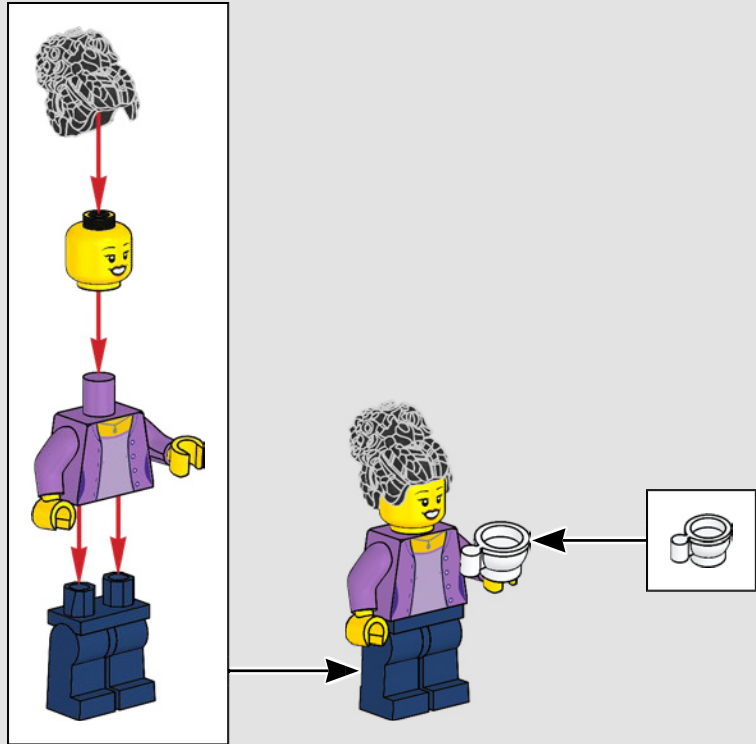

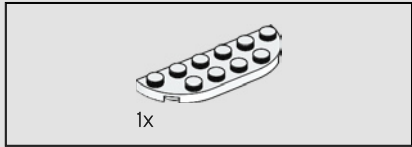

1x

1

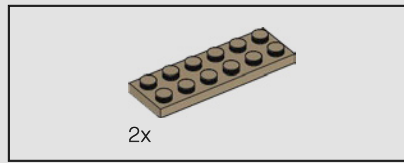

2x

2

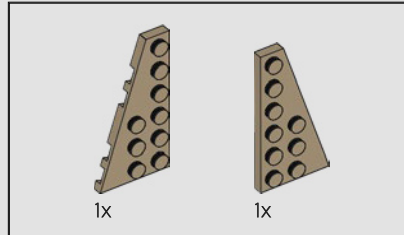
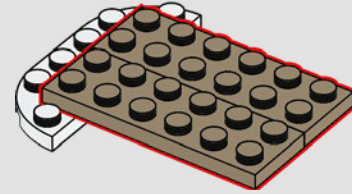

1x

1x

3

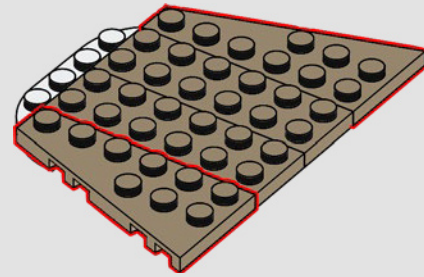

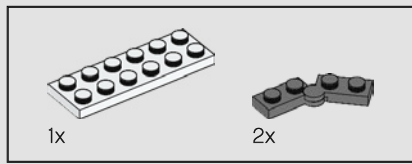

4

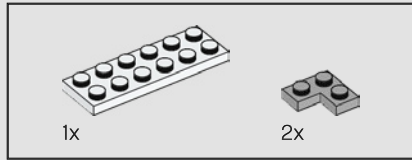
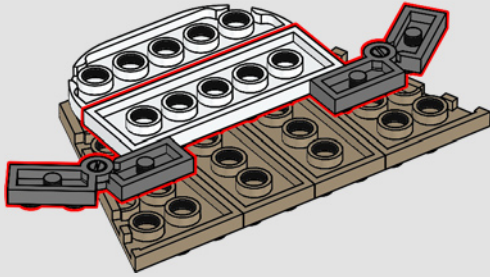

5

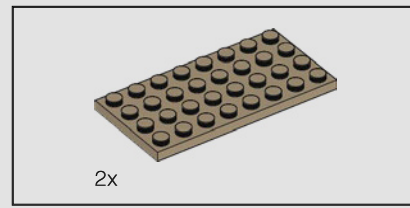
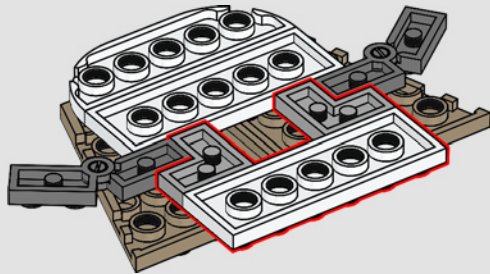

6

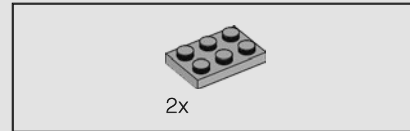
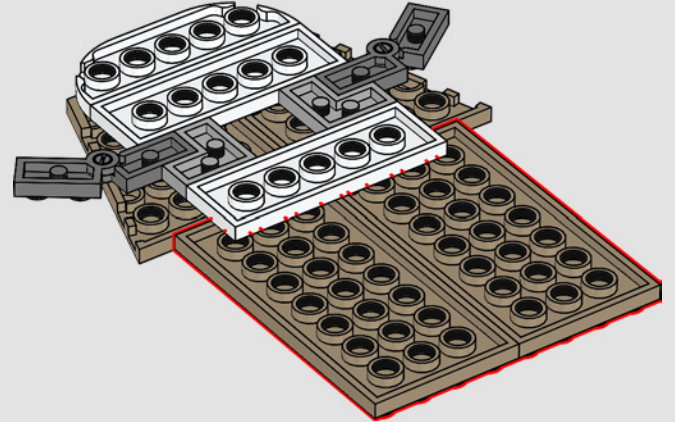

7

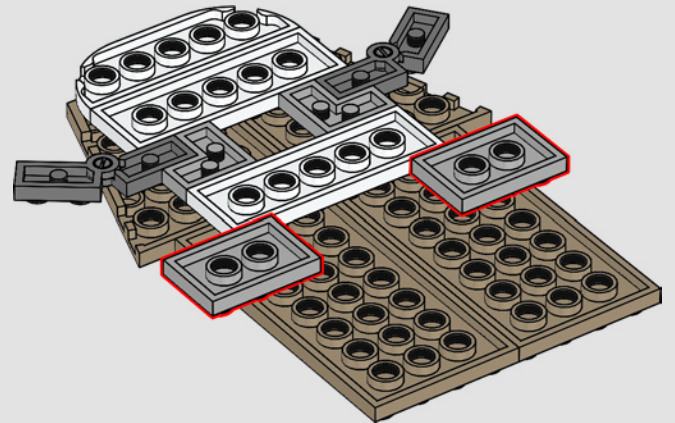

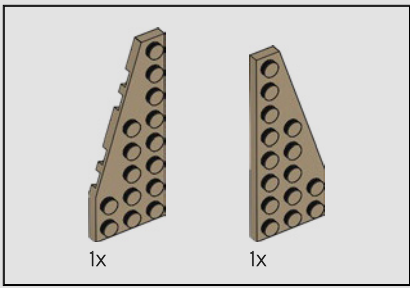

8

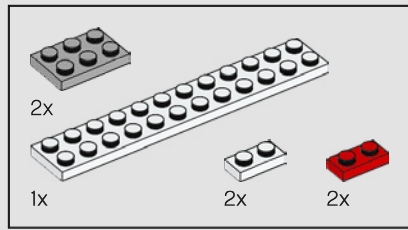
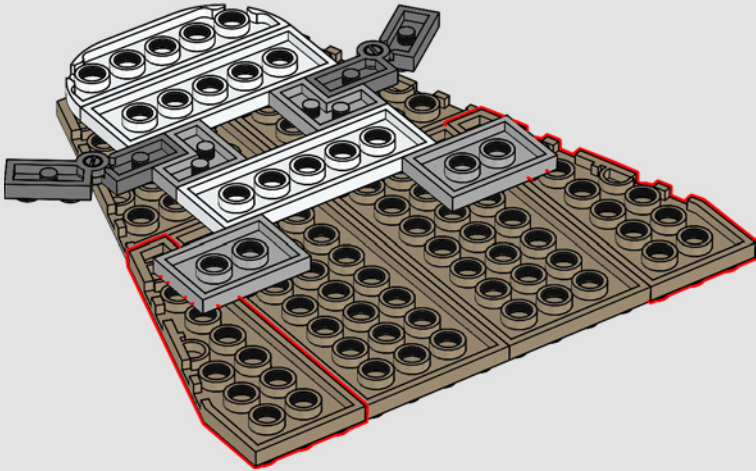

9

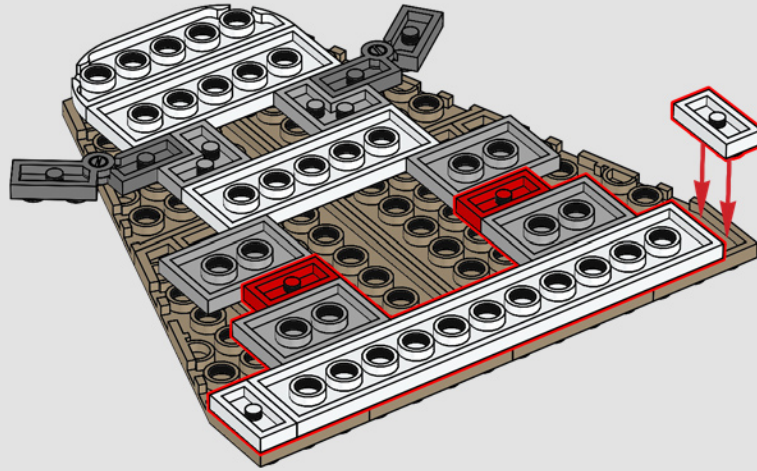

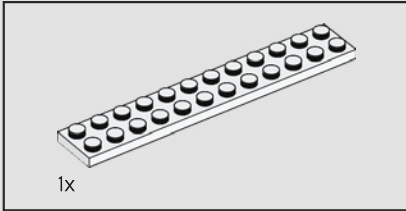
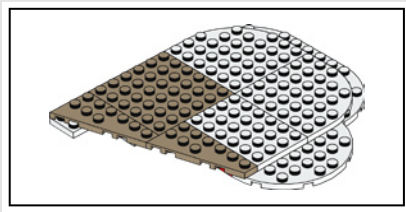

1x

10

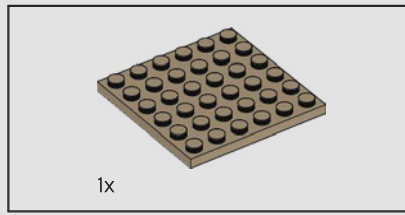
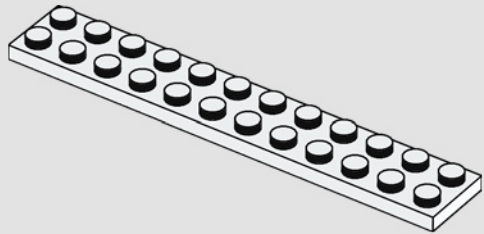

1x

11

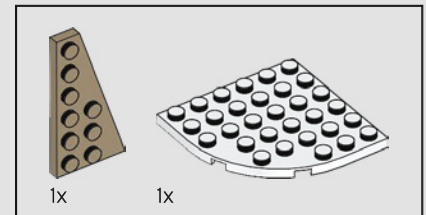
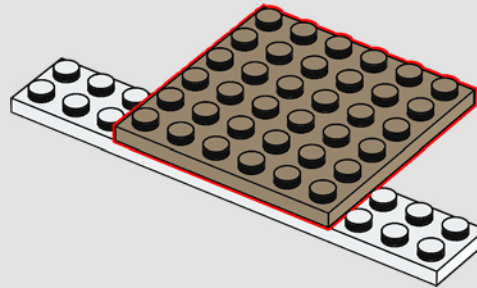

1x

1x

12

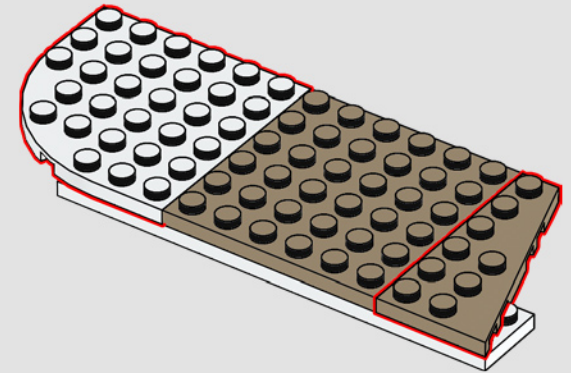

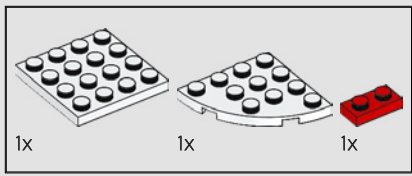

13

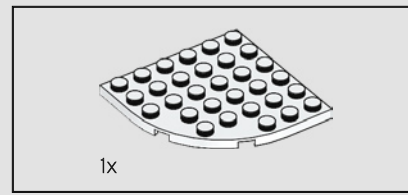
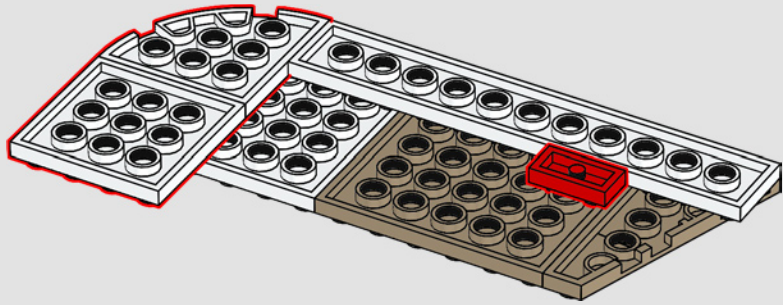

14

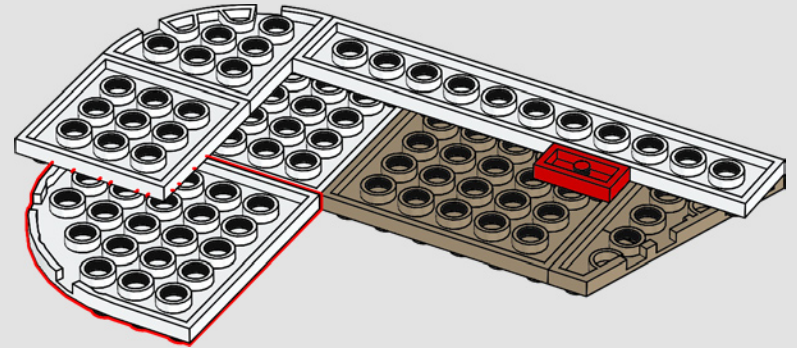

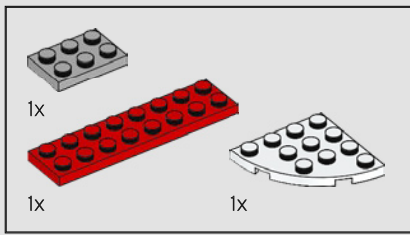

15

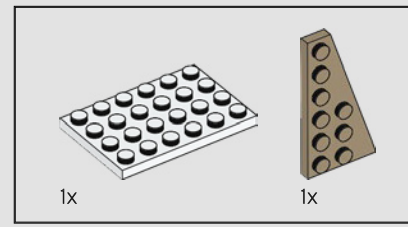
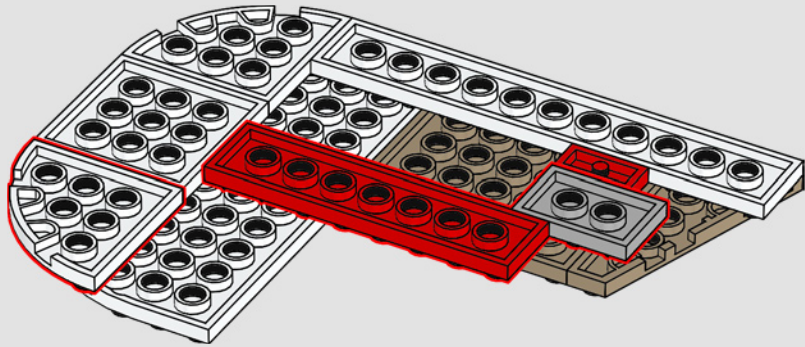

16

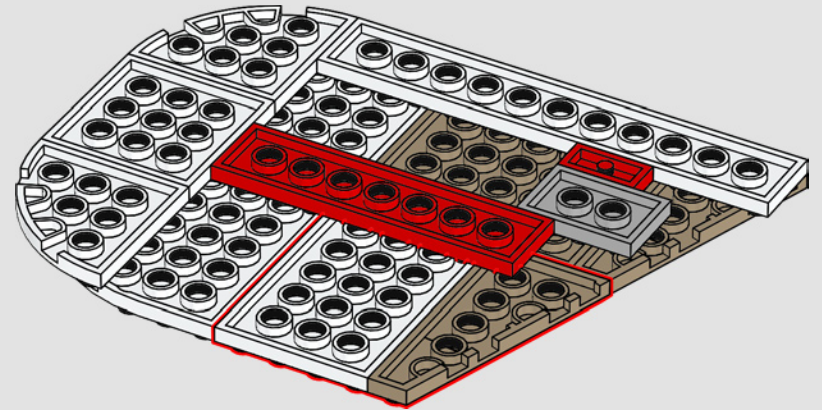

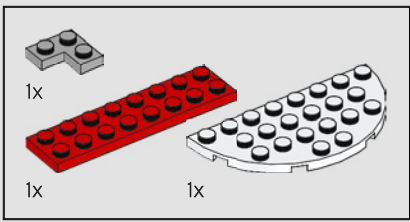

17

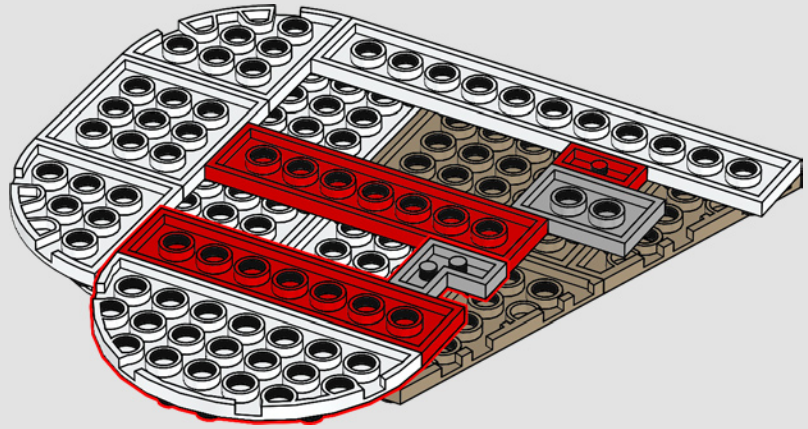

18

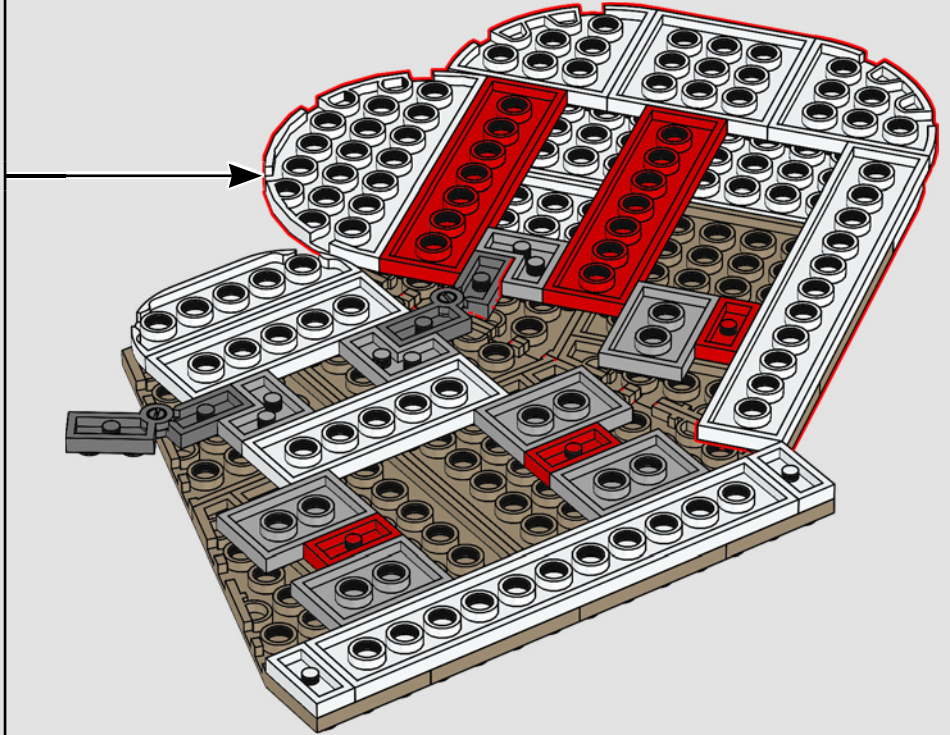

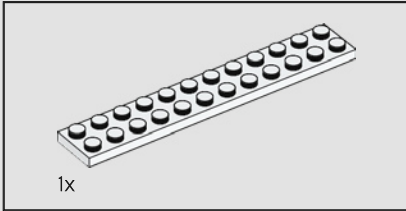
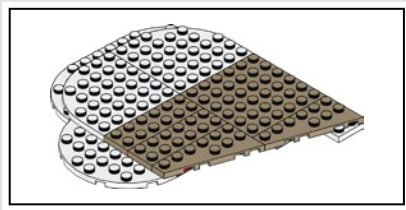

19

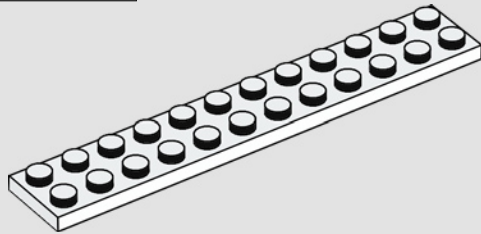

20

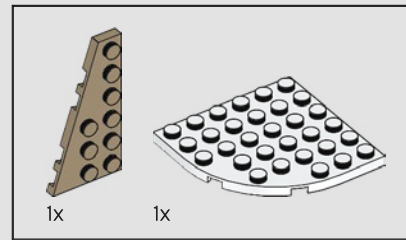
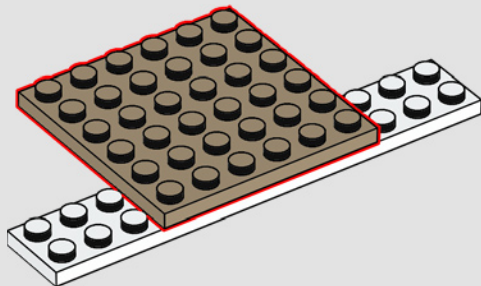

21

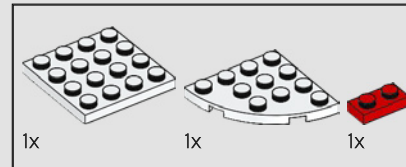
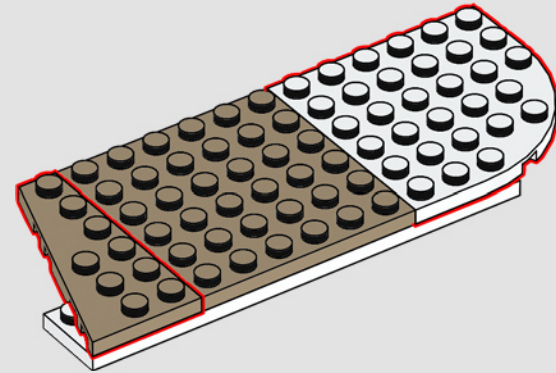

22

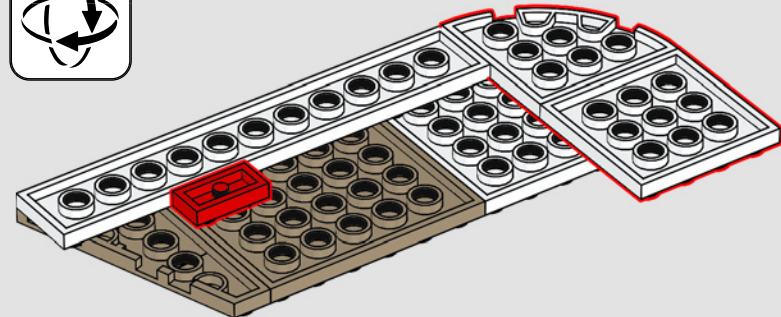
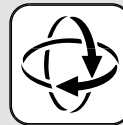

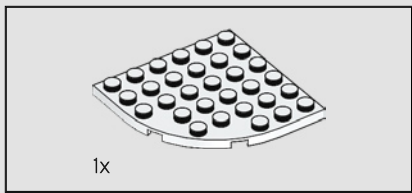

23

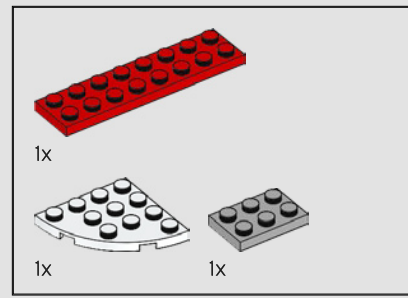
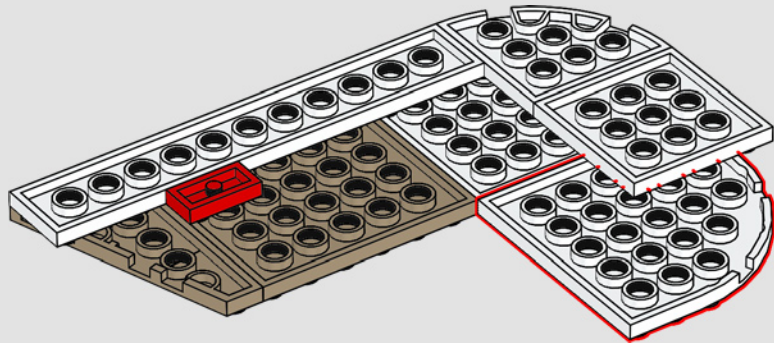

24

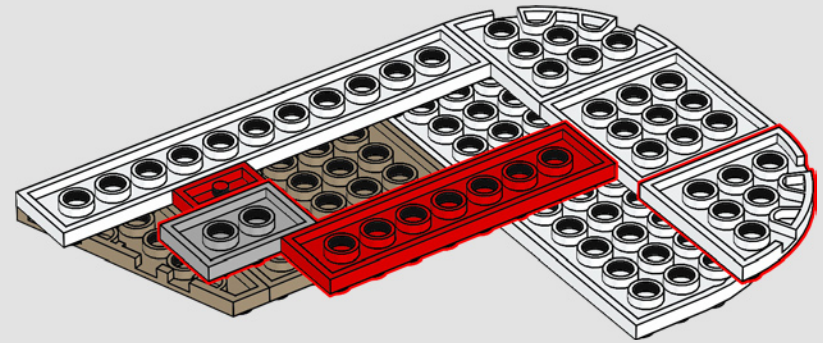

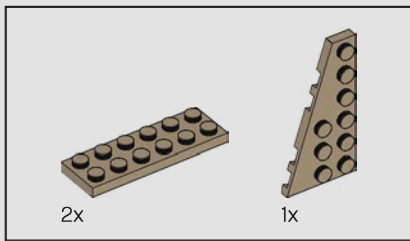

25

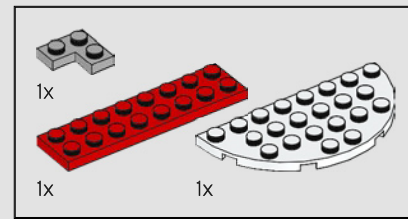
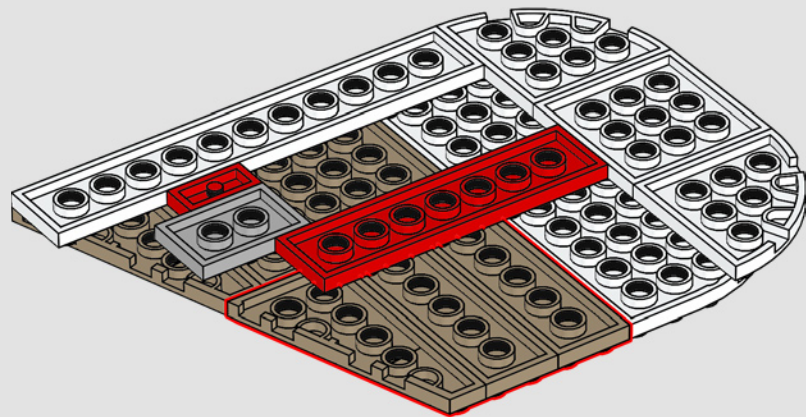

26

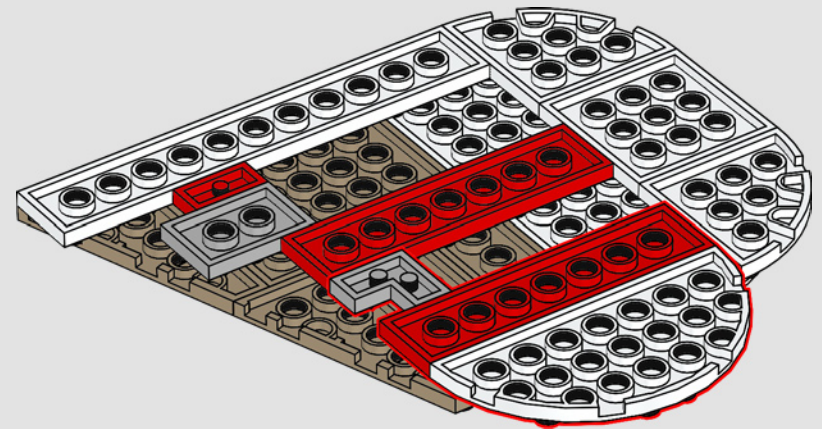

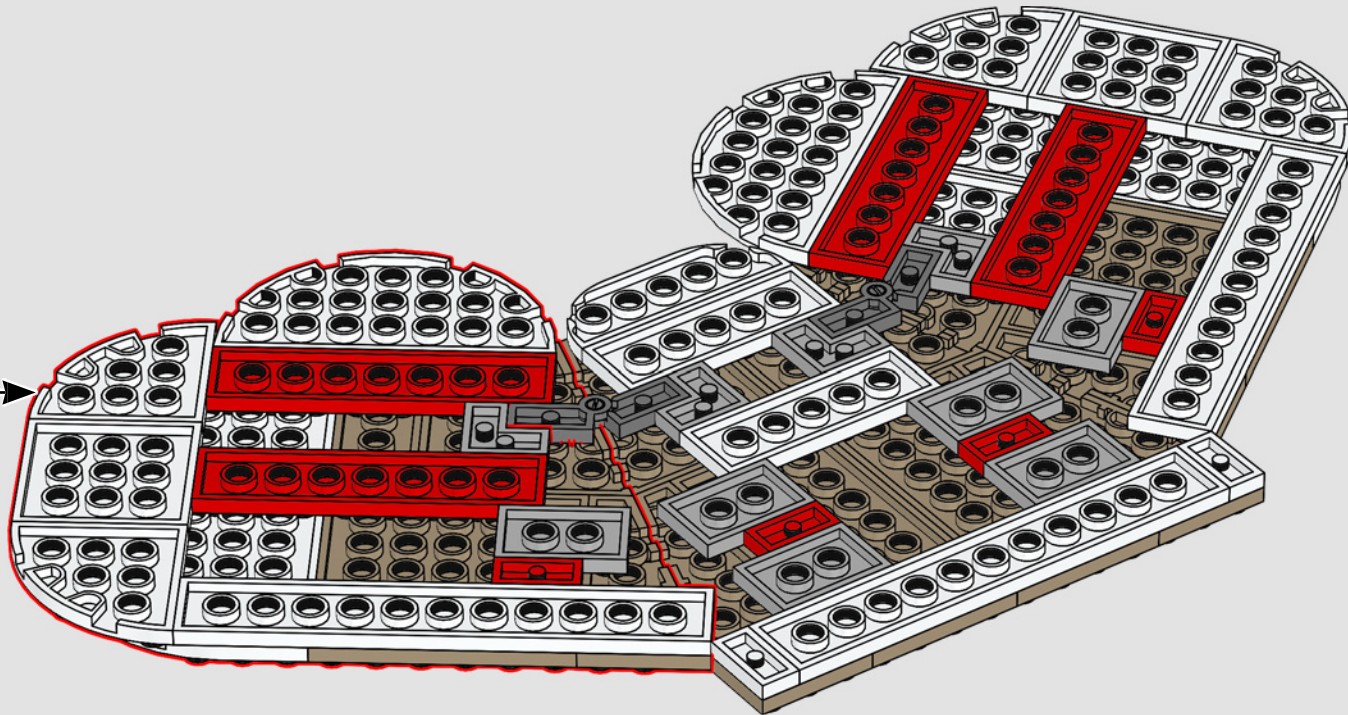

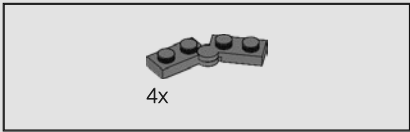

28

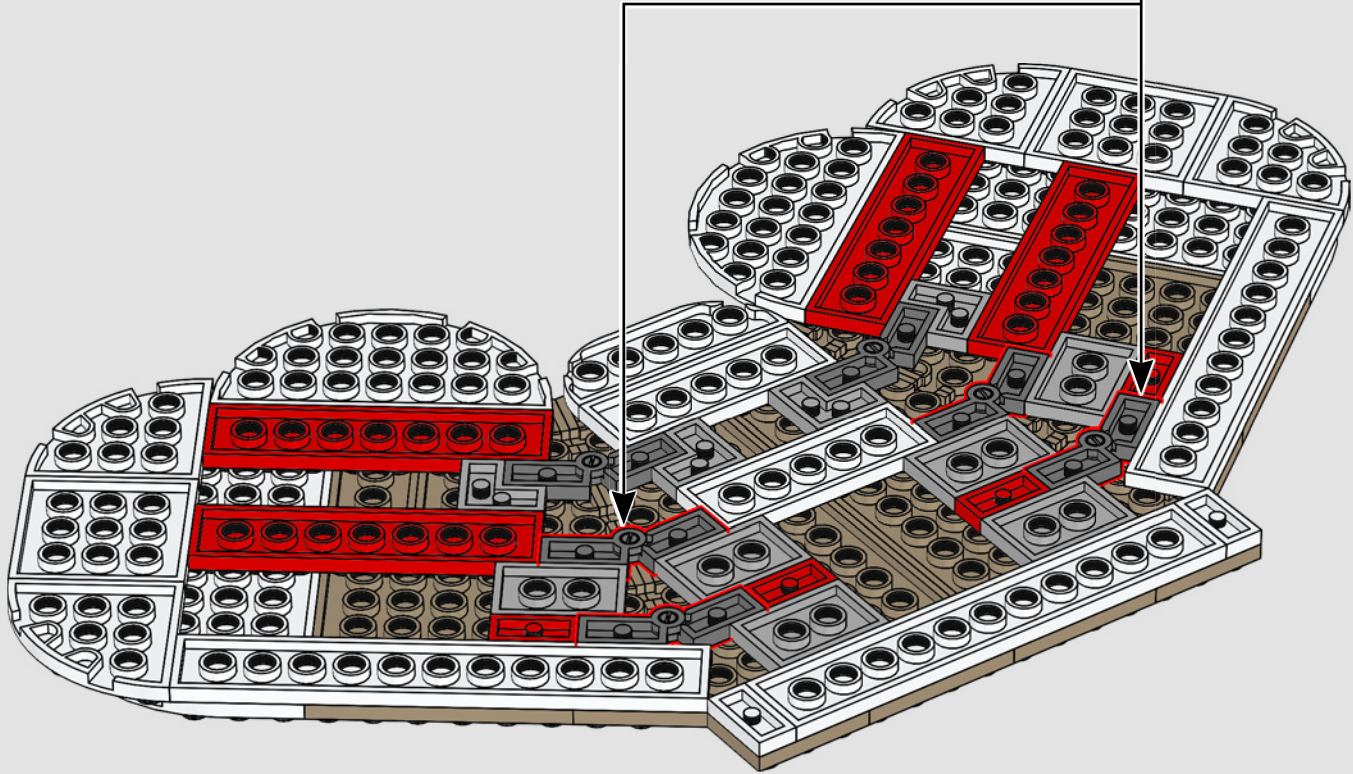
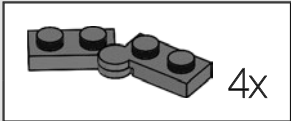

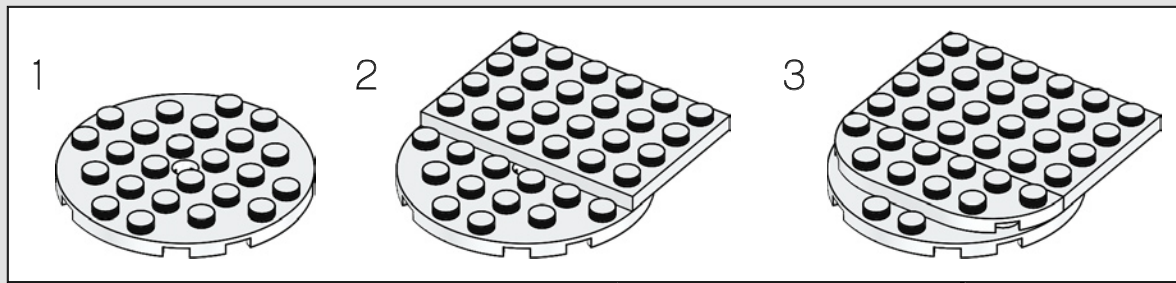
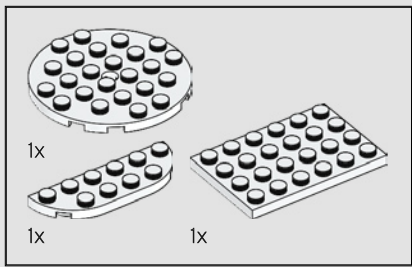

29

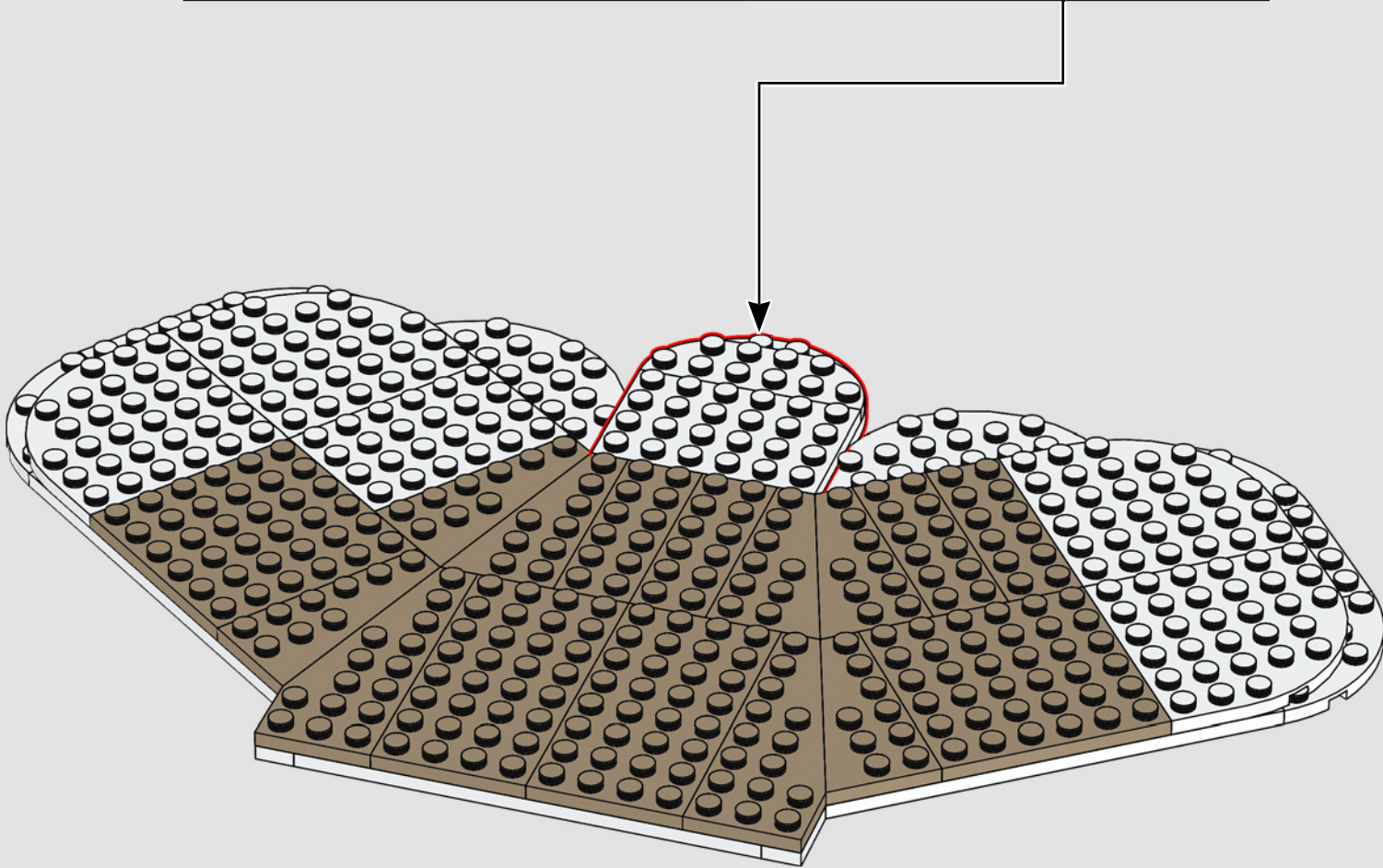

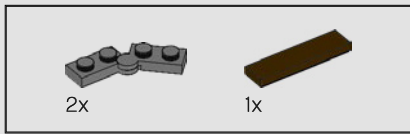

30

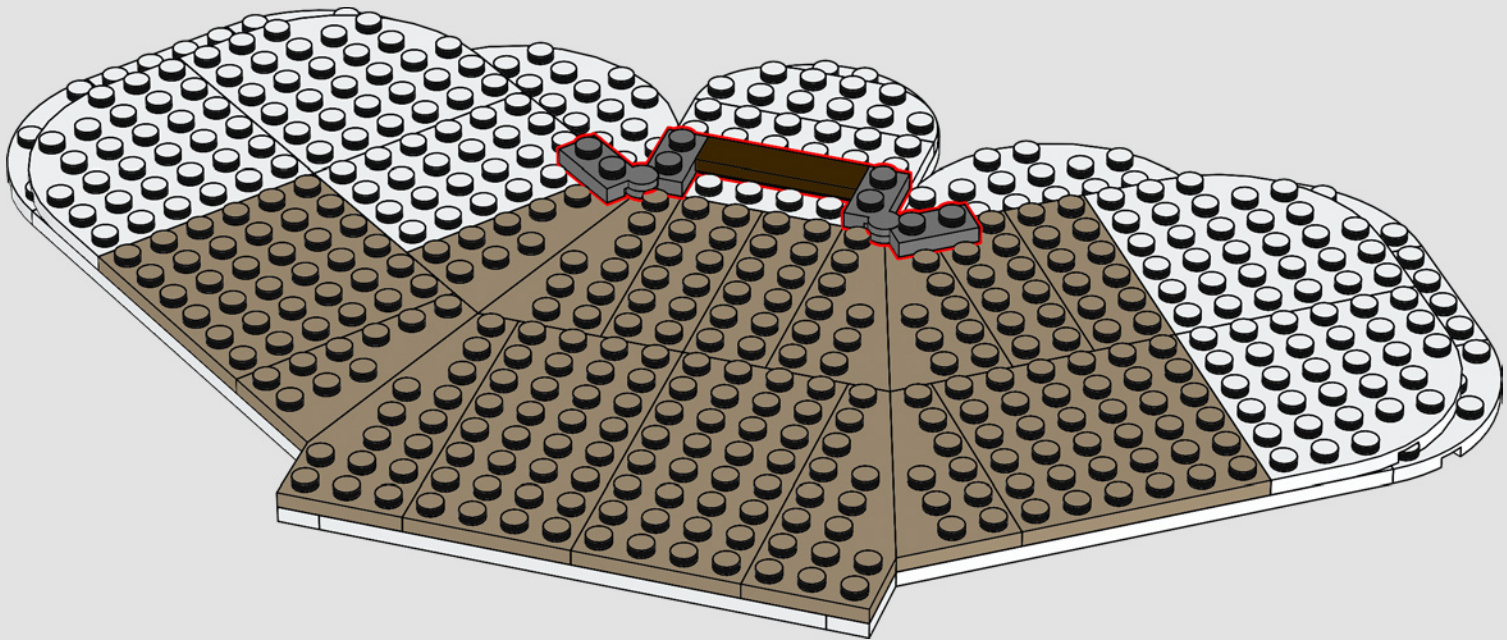

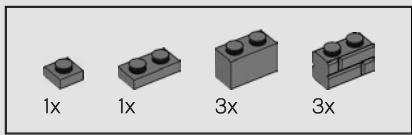

31

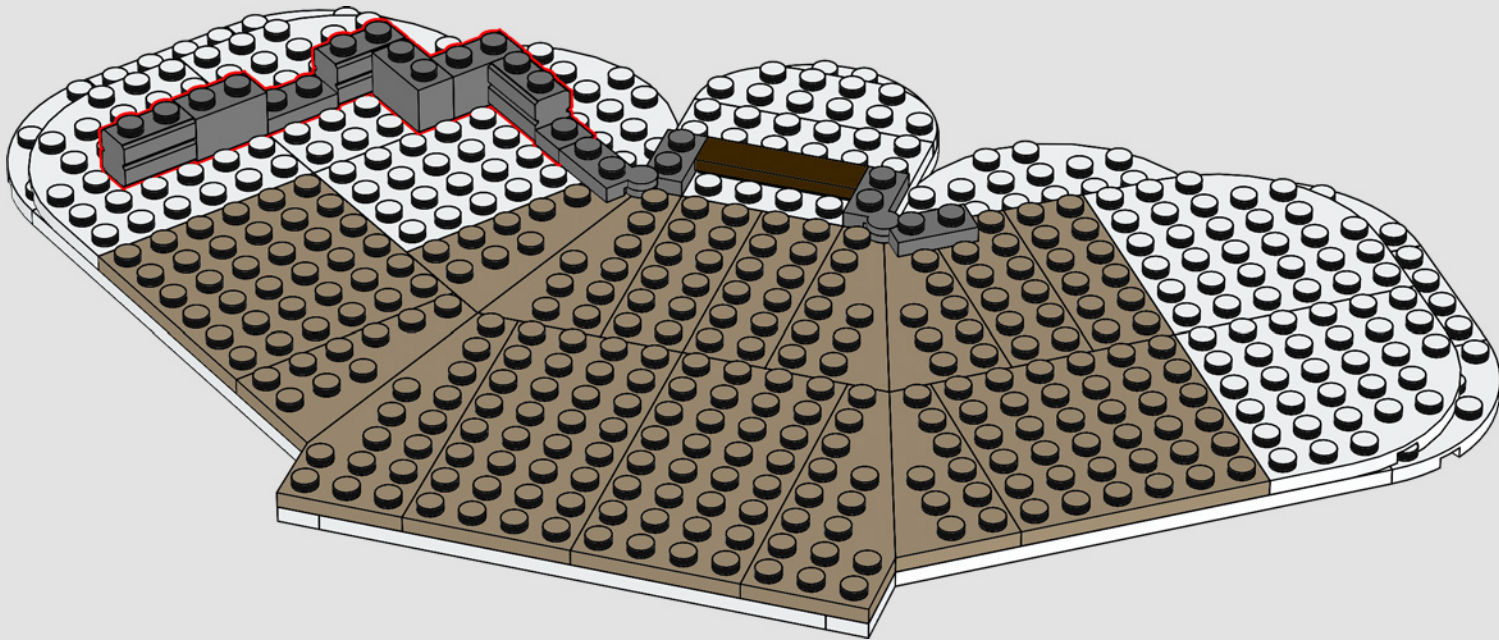

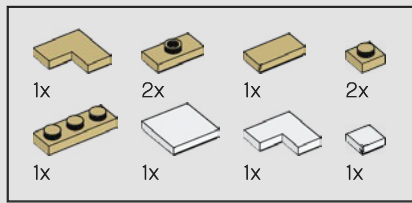

32

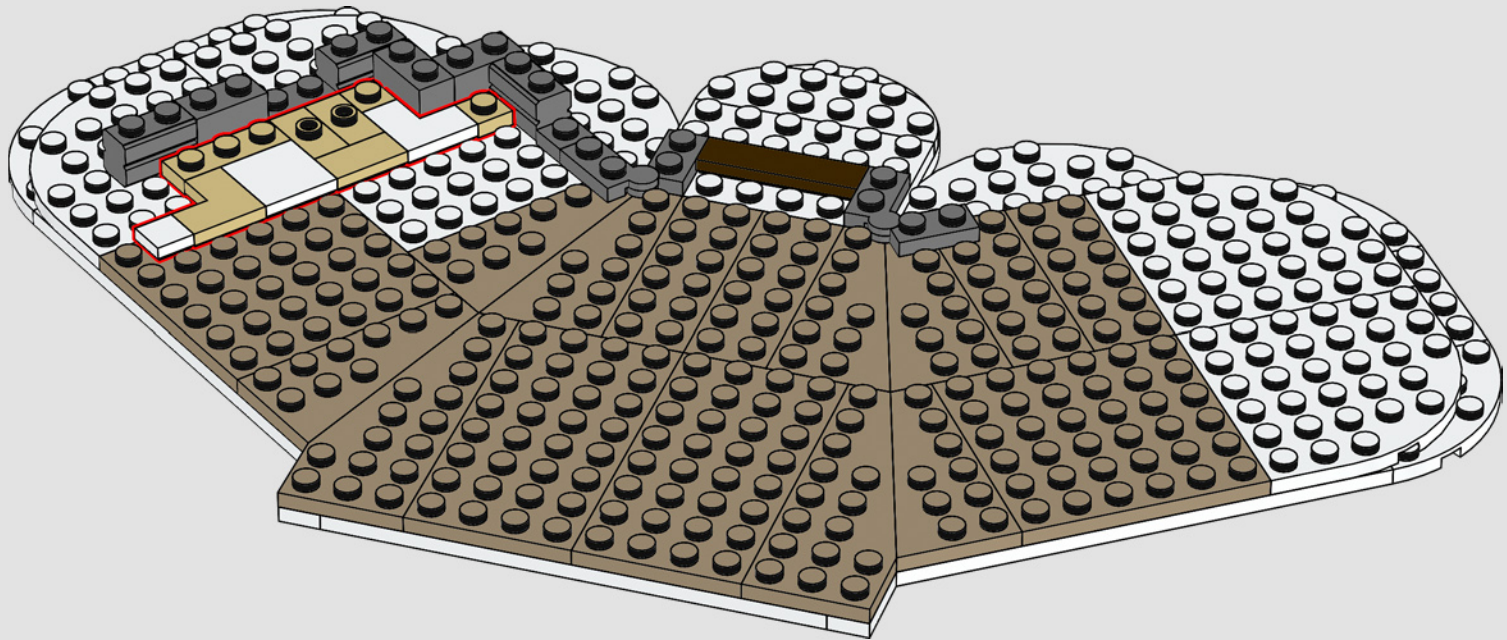

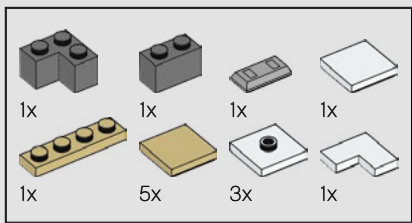

33

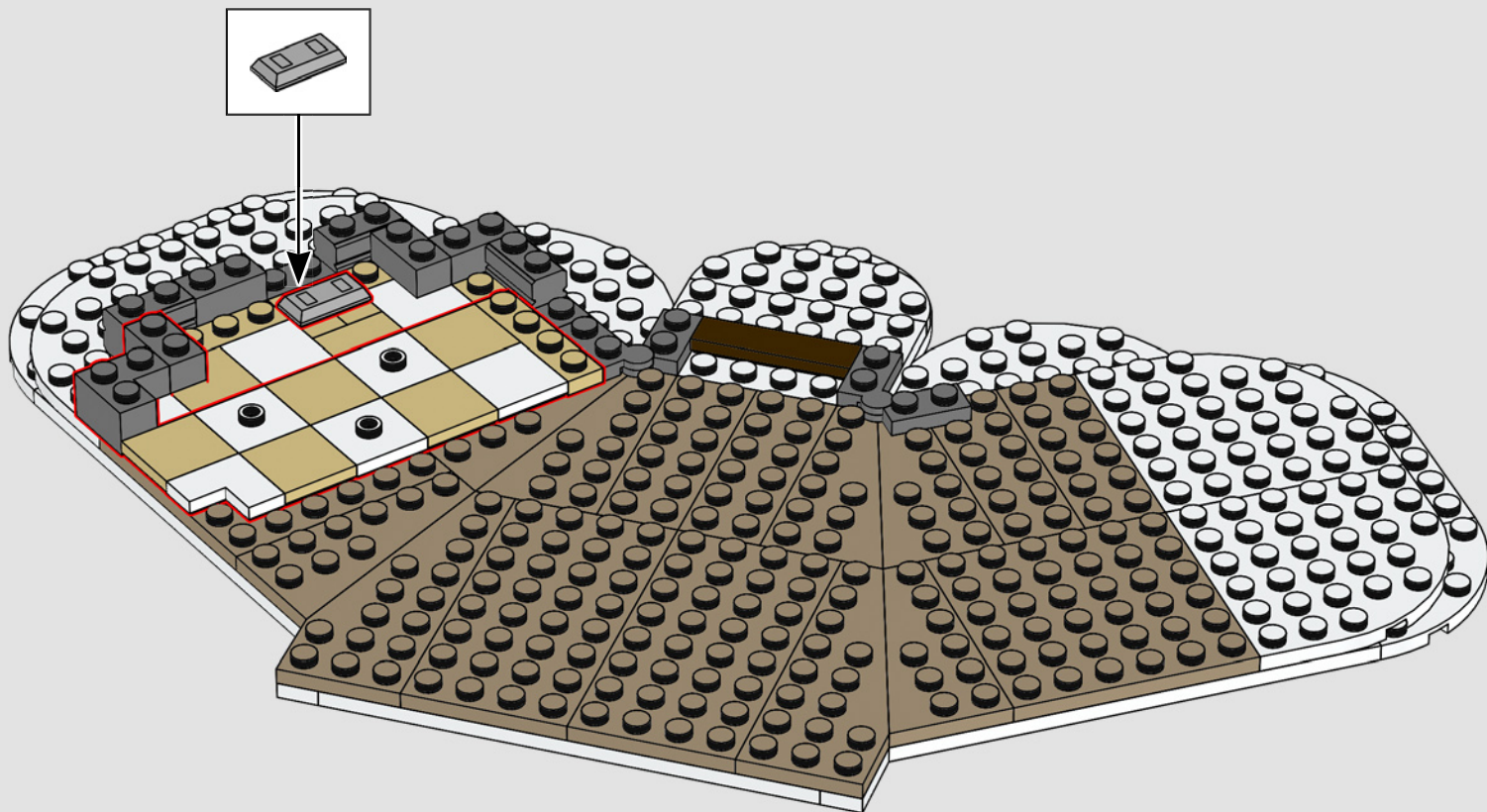

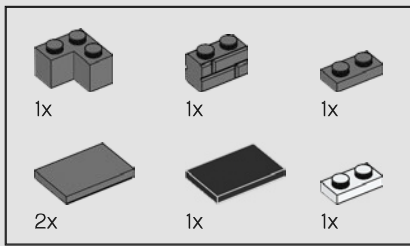

34

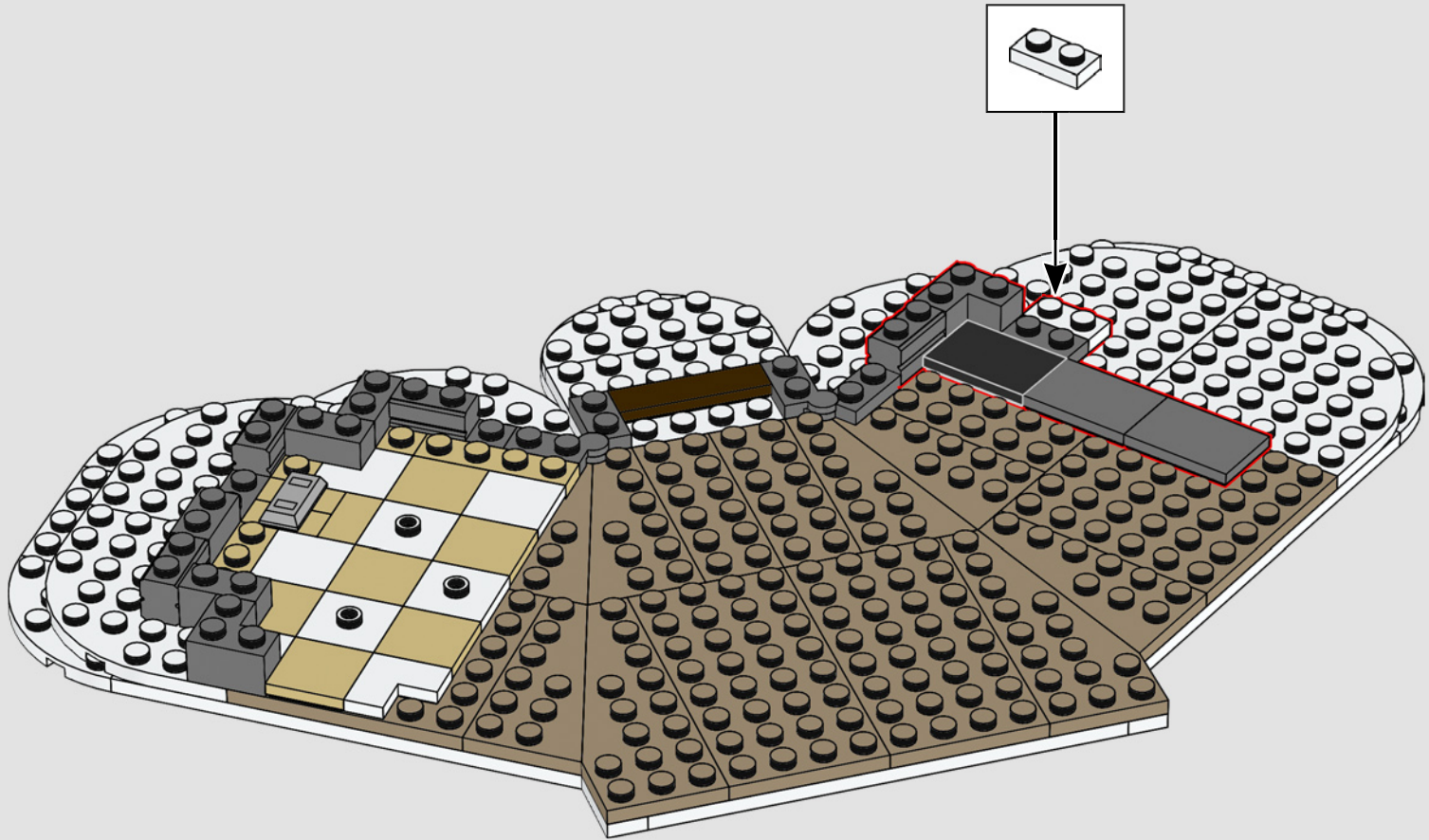

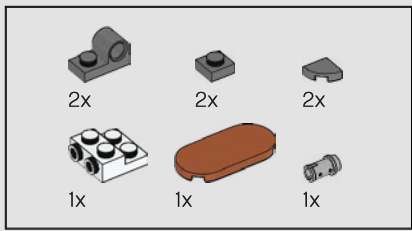

35

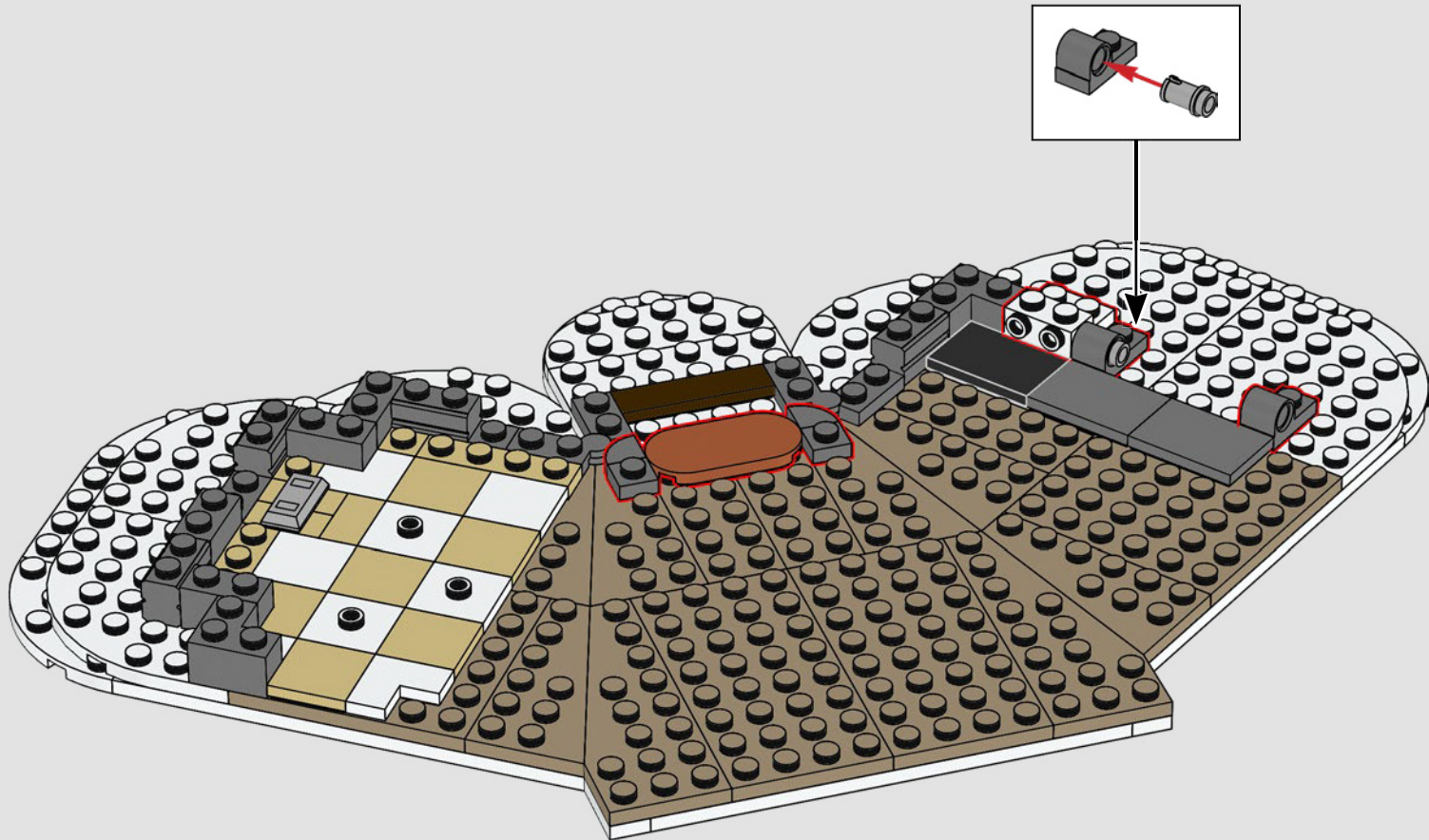

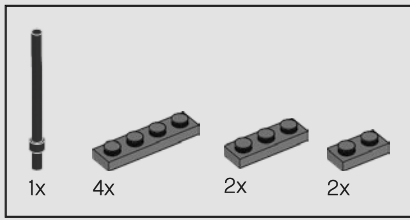

36

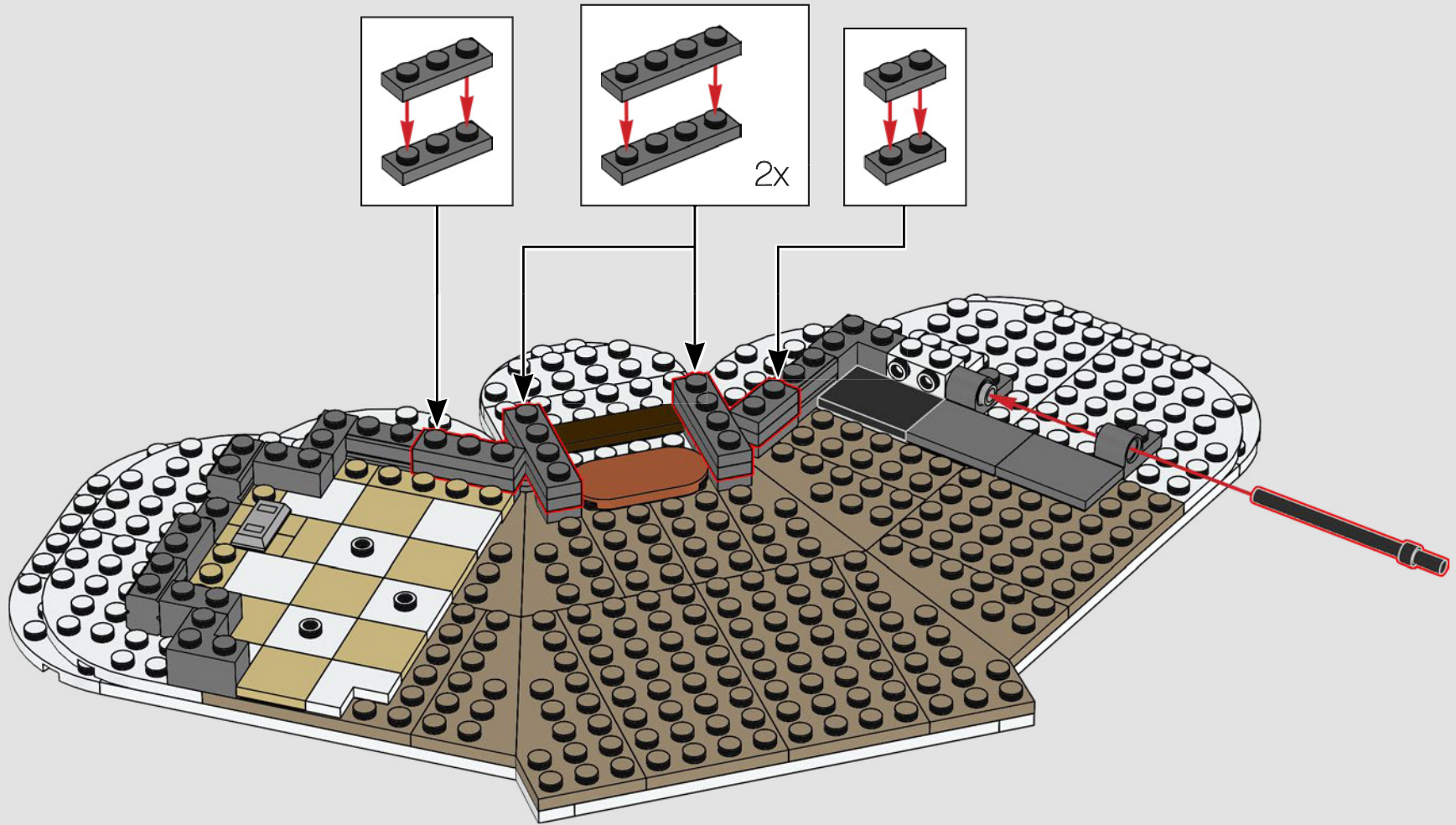

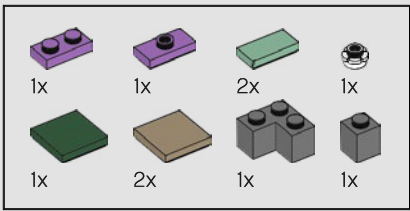

37

Im ganzen Haus sind Geschenke versteckt,
um sie vor den neugierigen Kindern zu verbergen.
Viele Eltern werden das kennen!

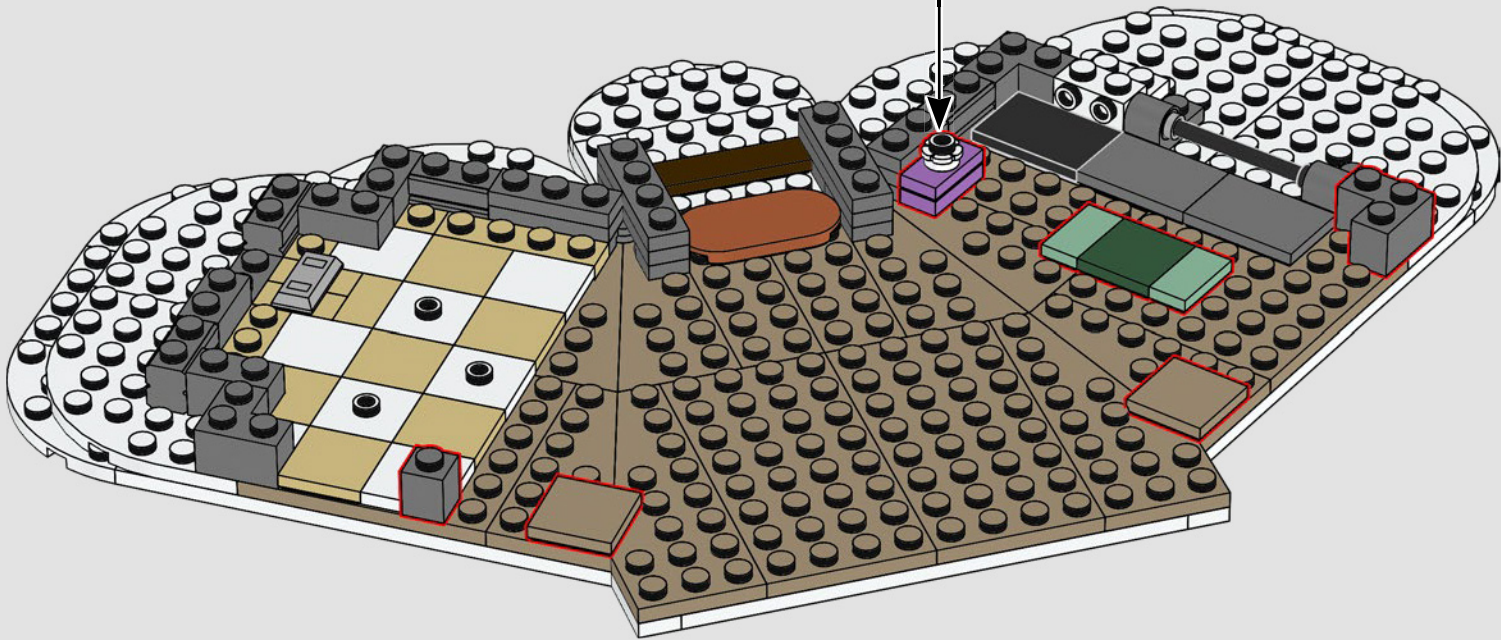
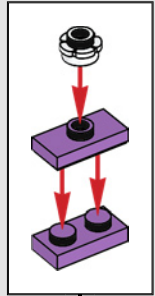

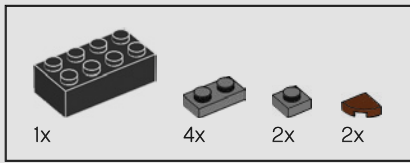

38

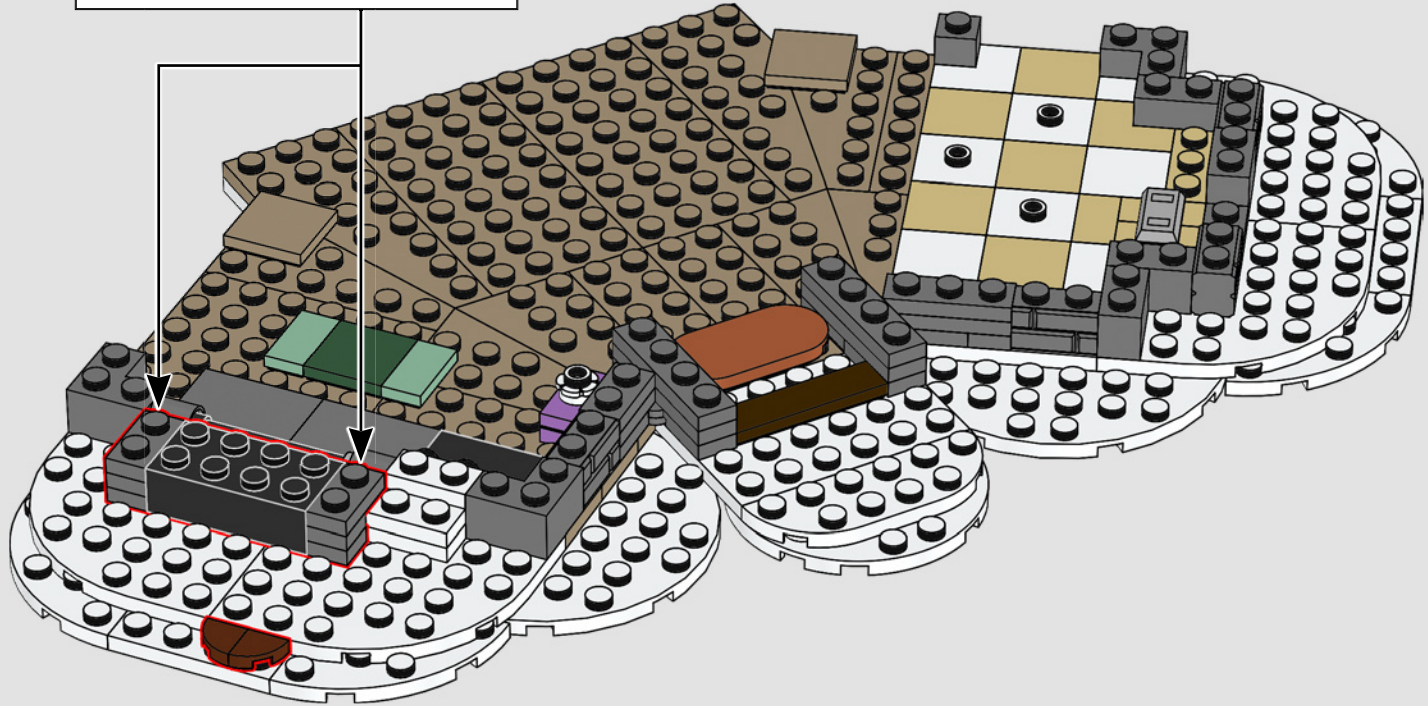
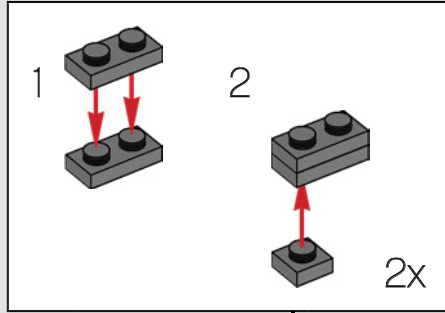

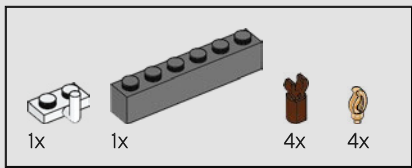

39

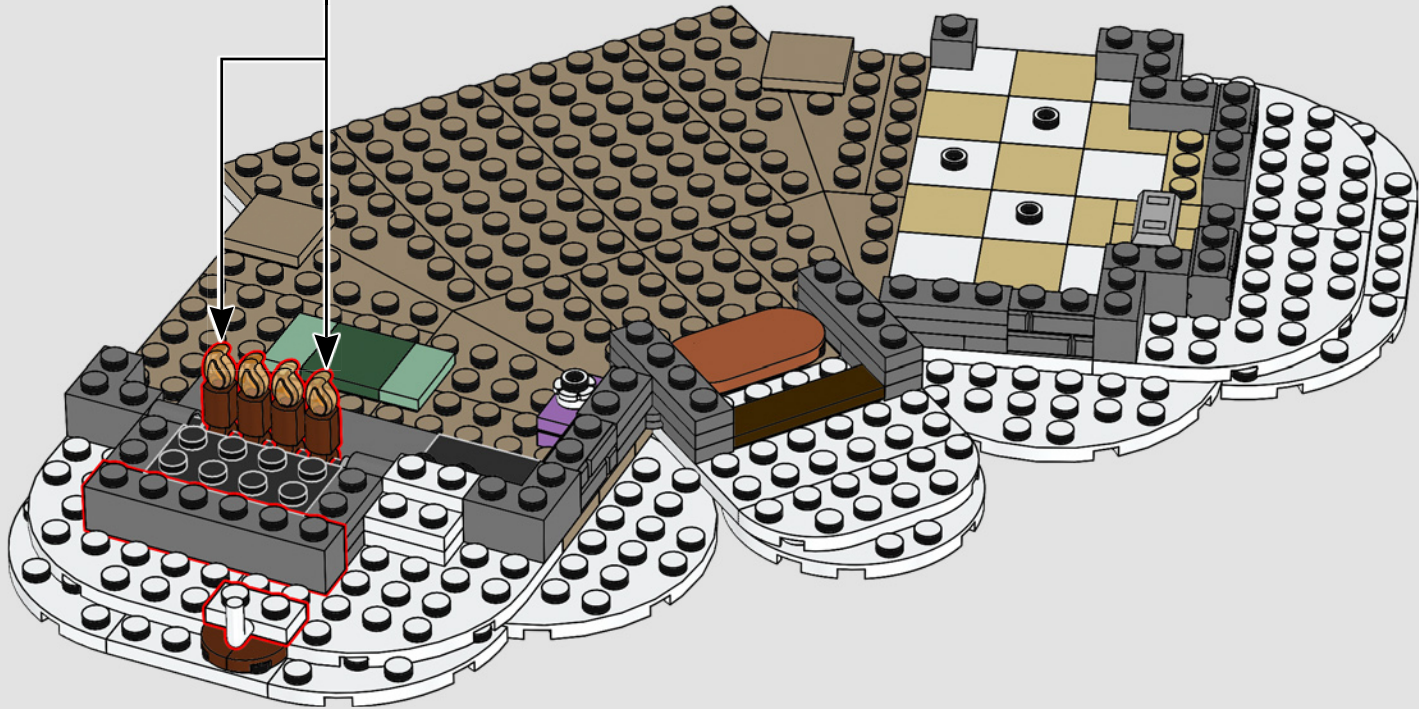
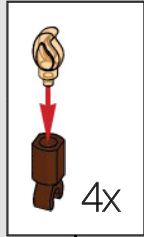

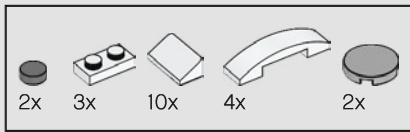

40

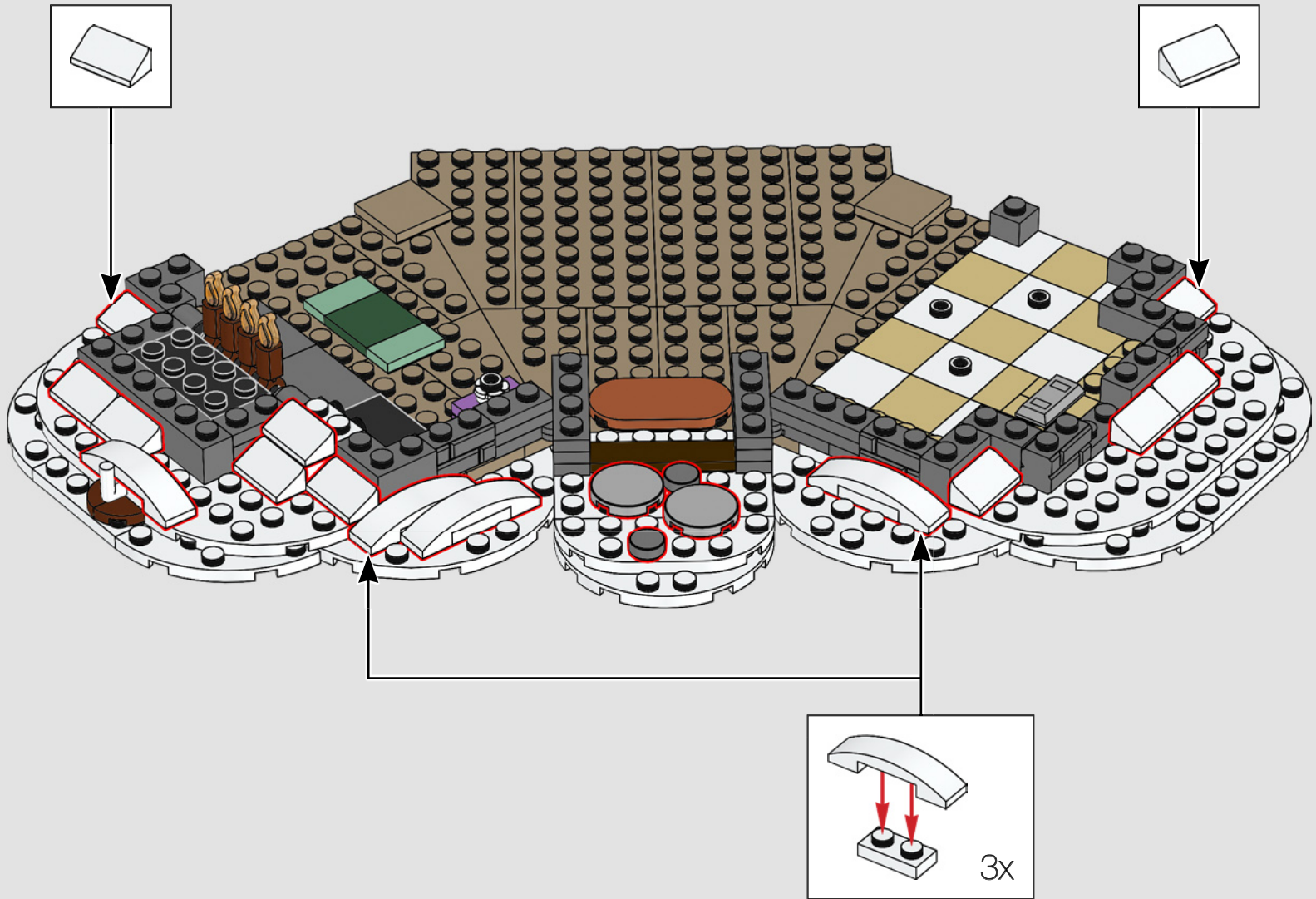

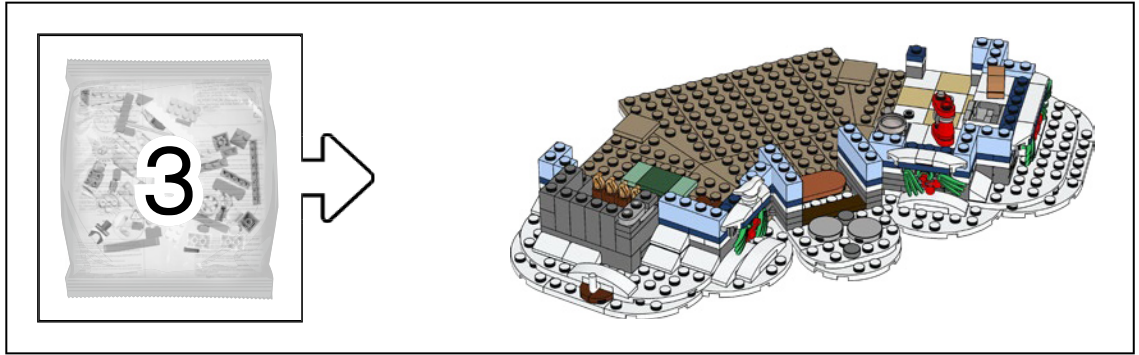

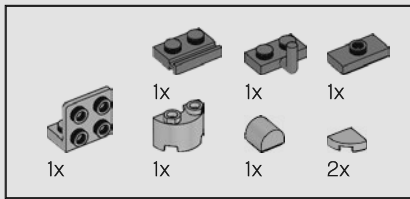

41

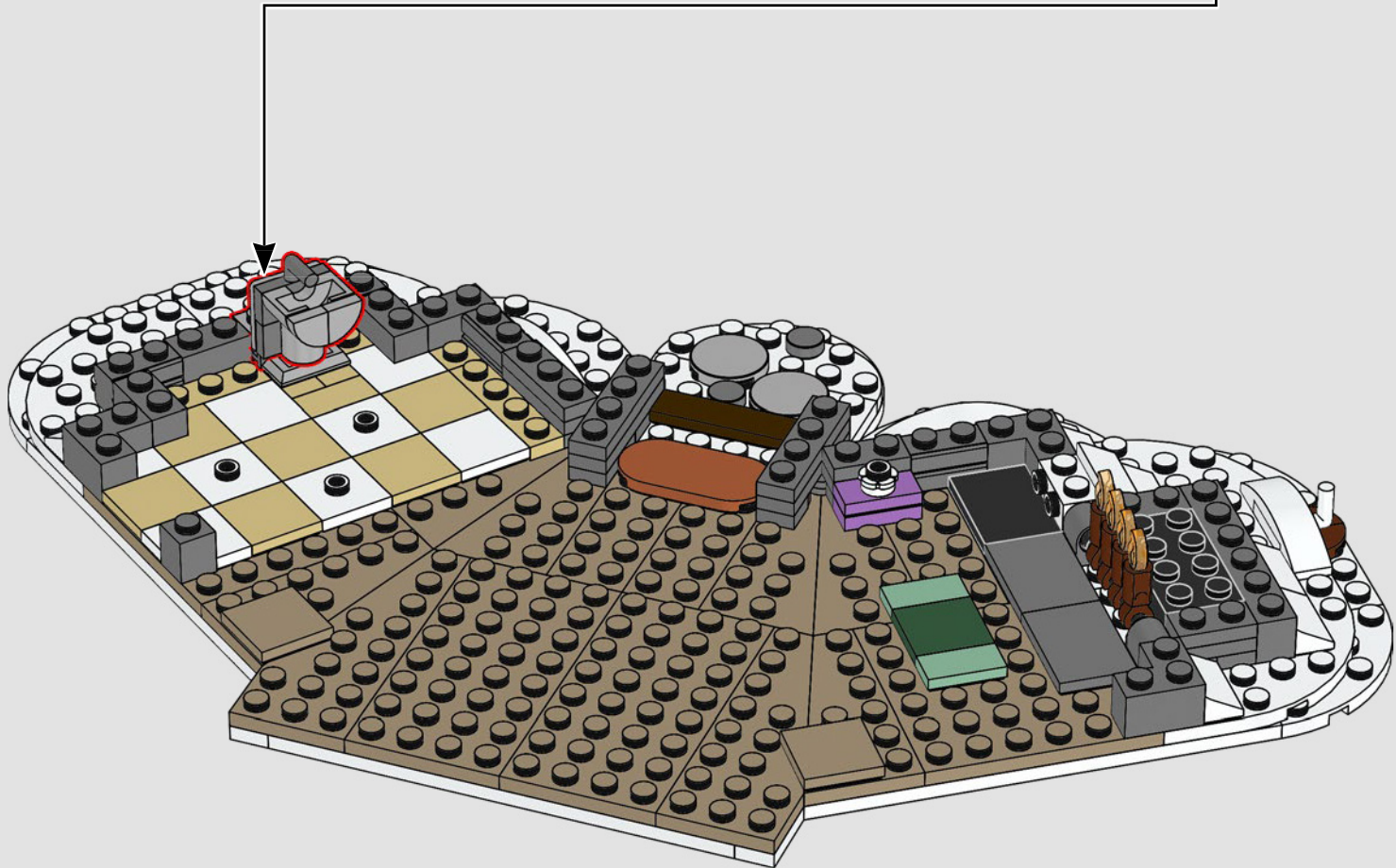
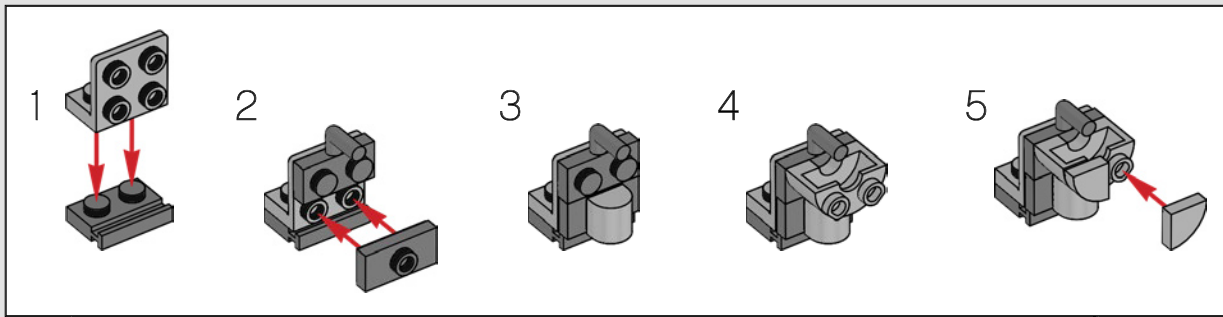

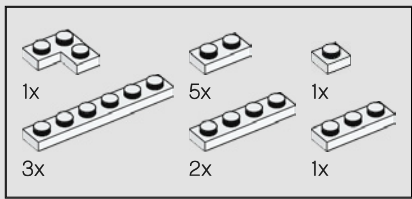

42

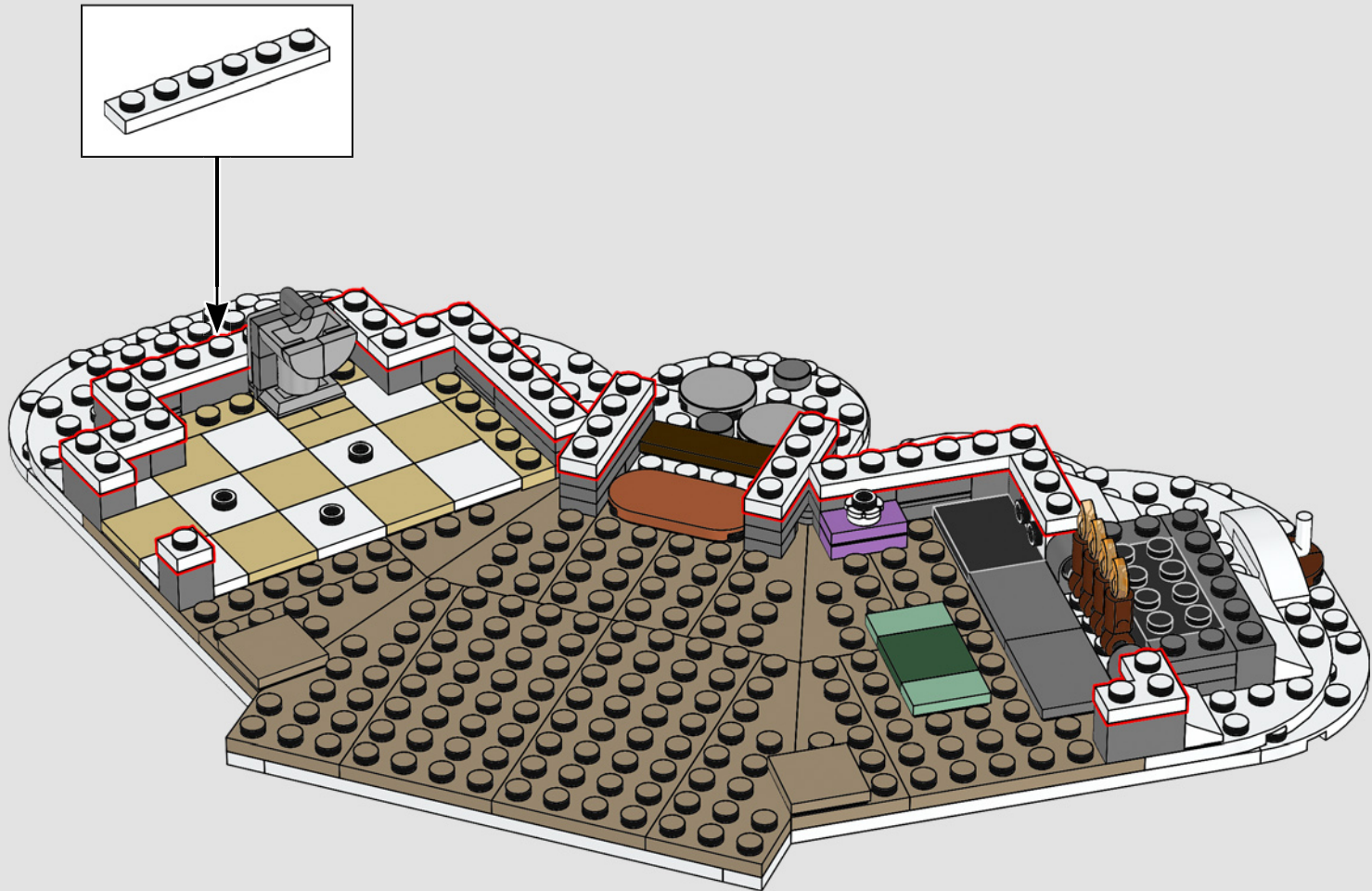

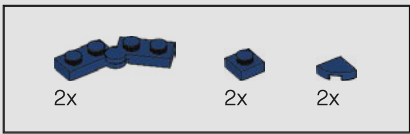

43



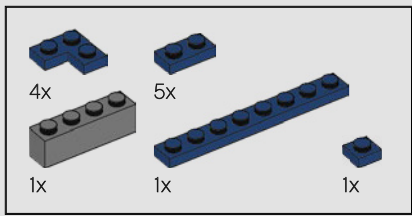

44

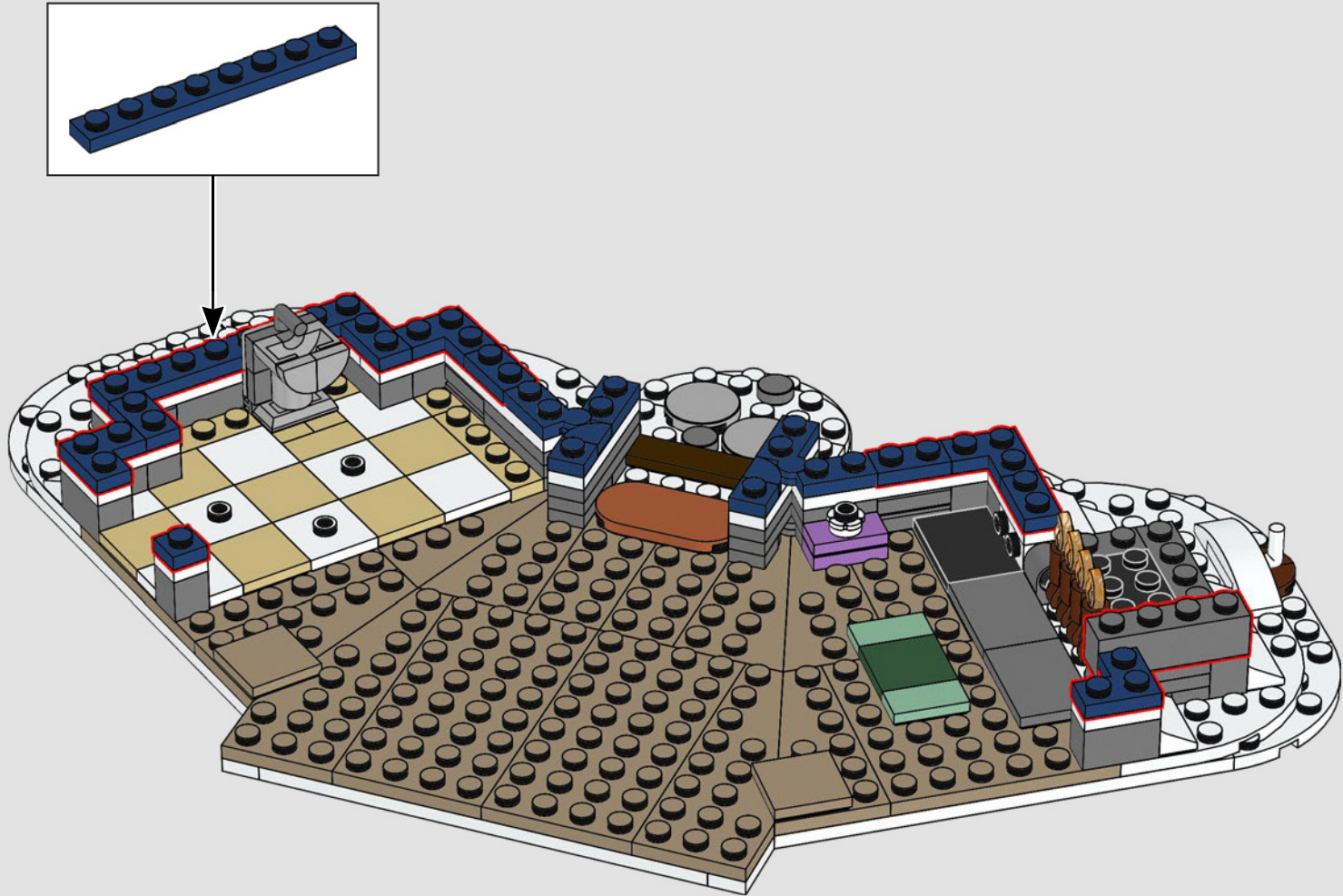

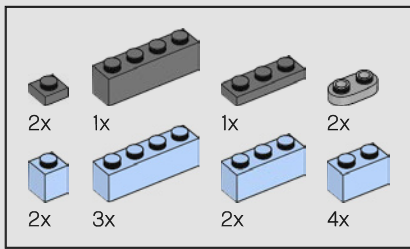

45

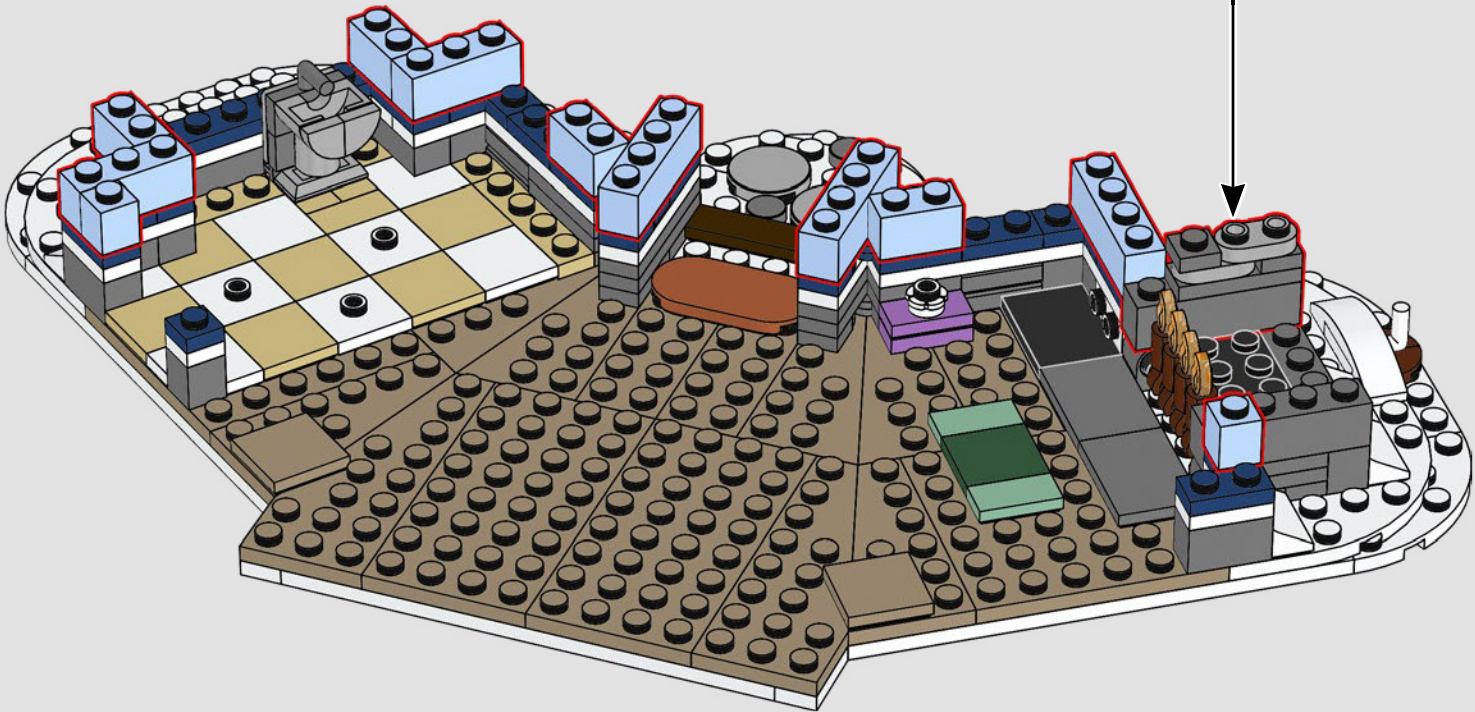
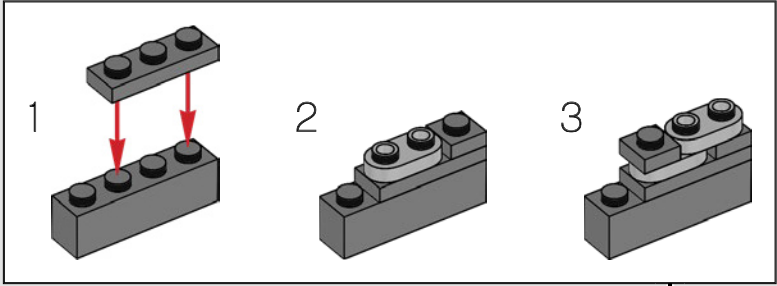

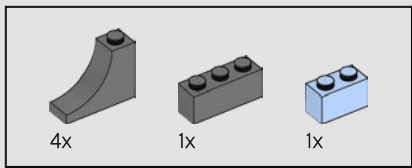

46

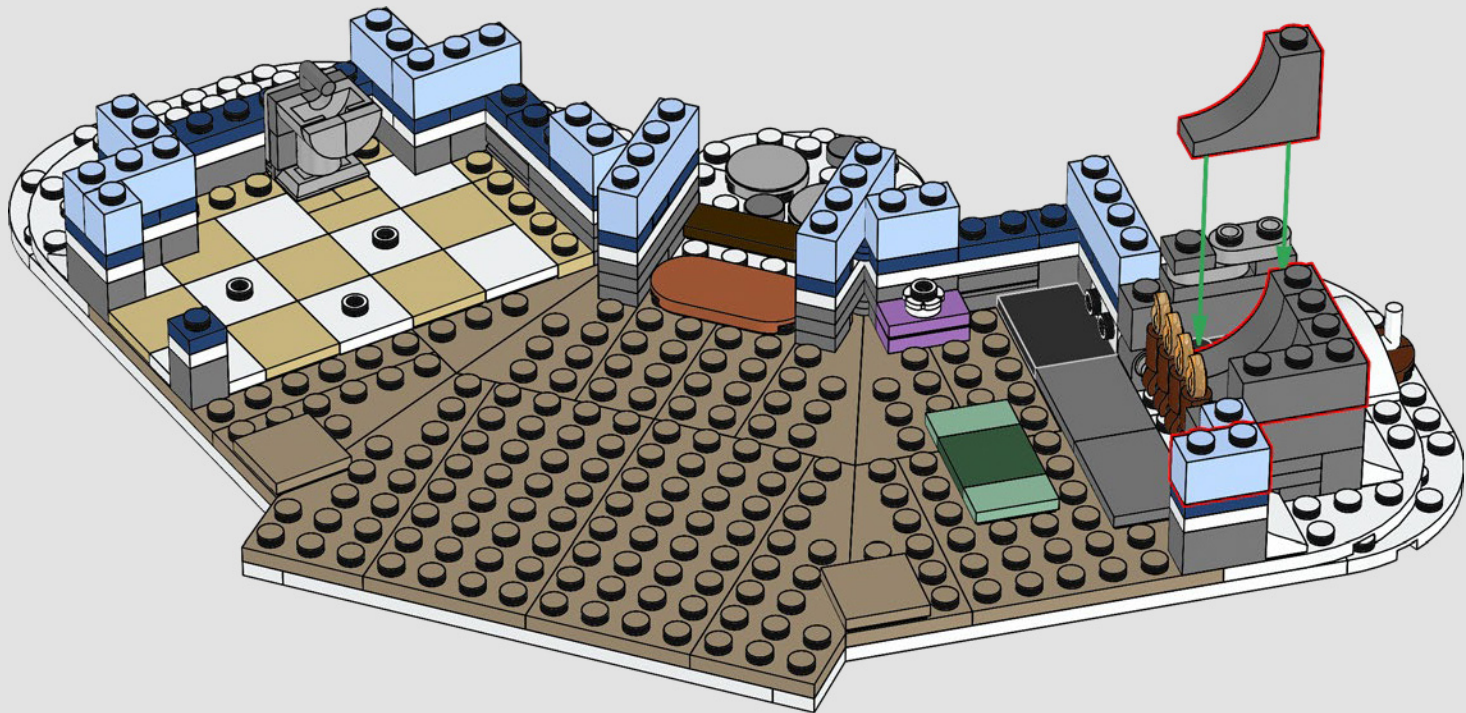

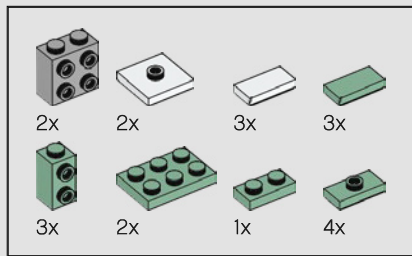

47

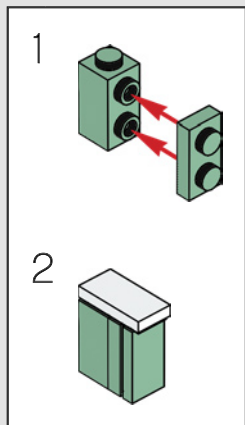
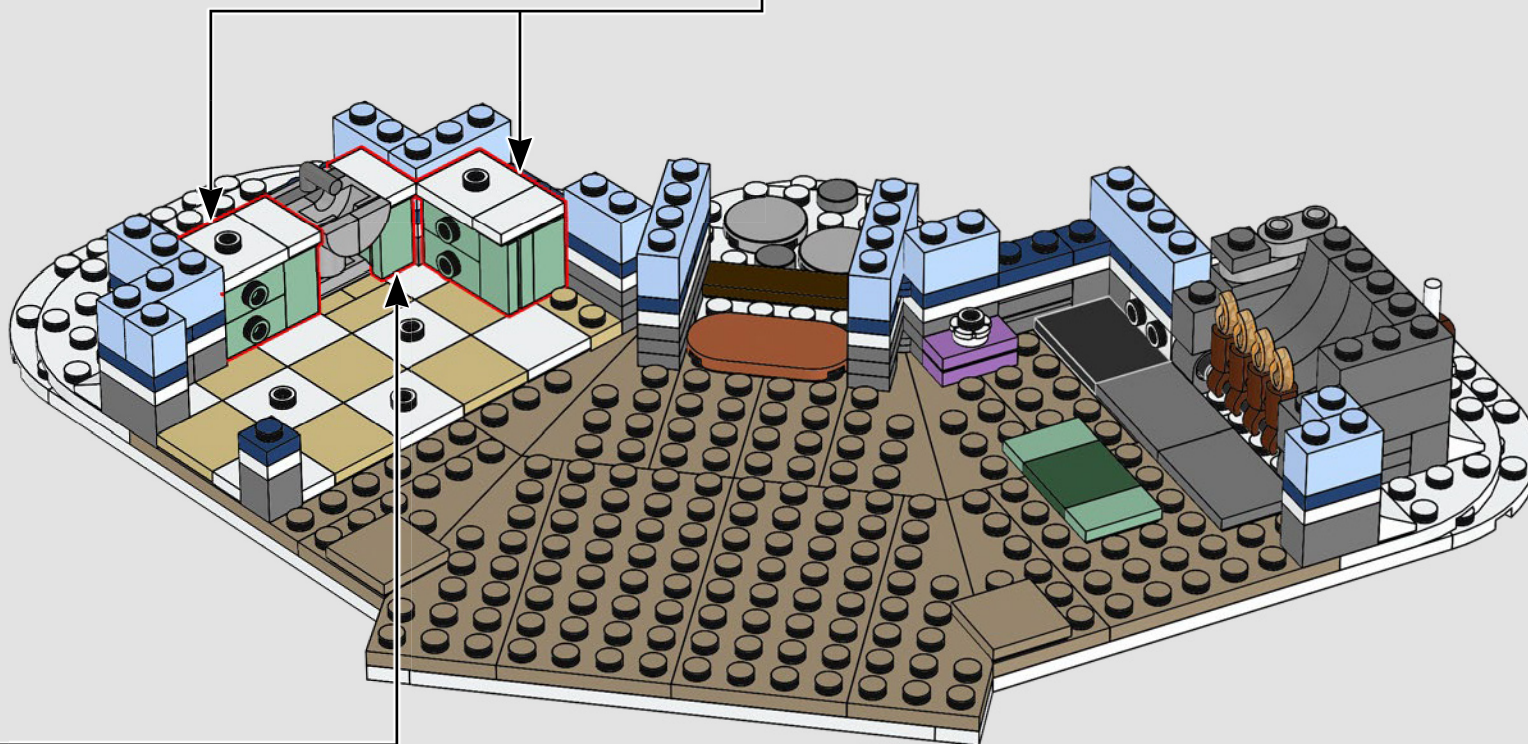
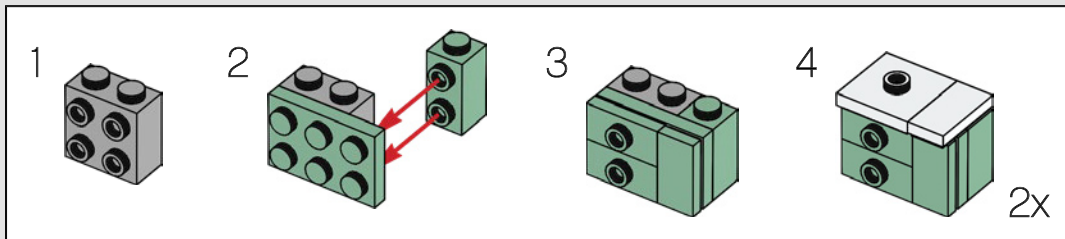

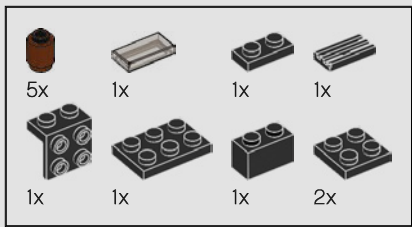

48

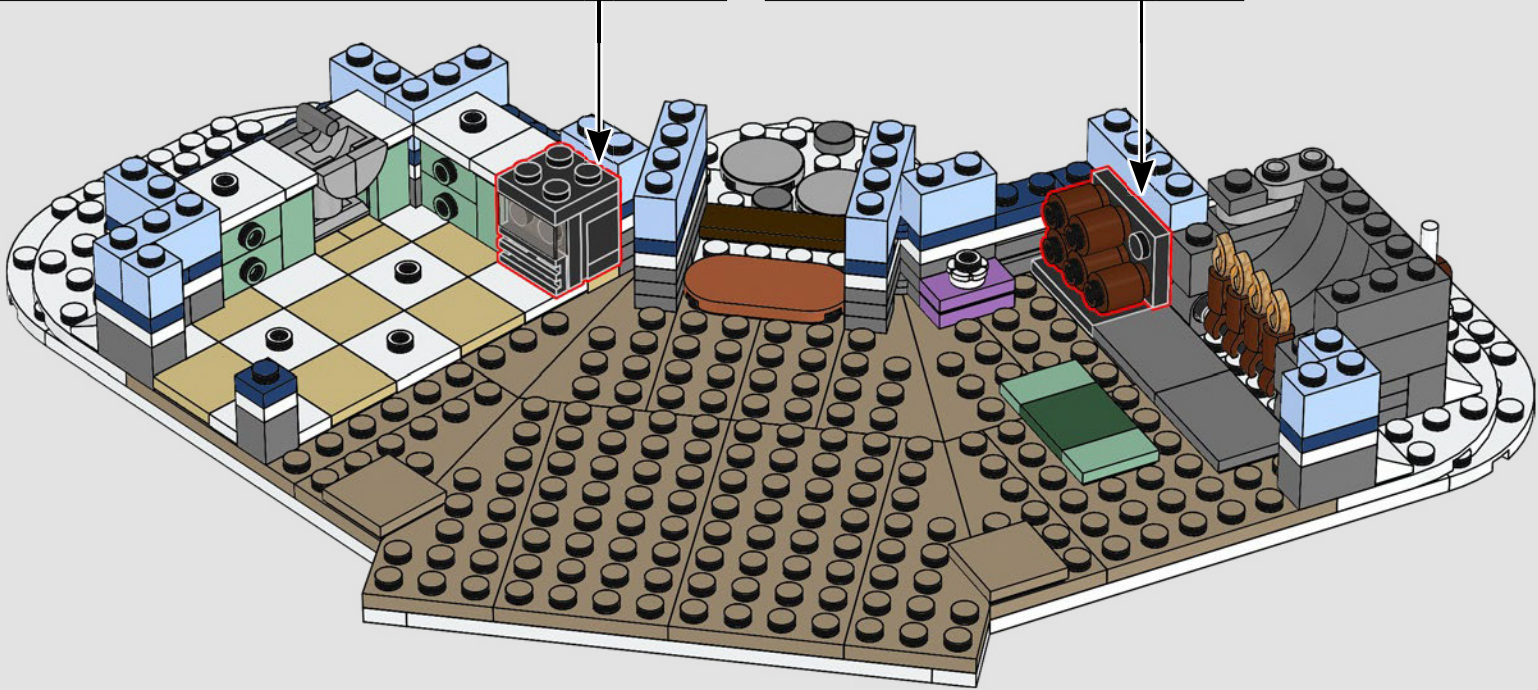
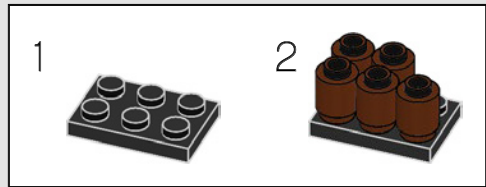
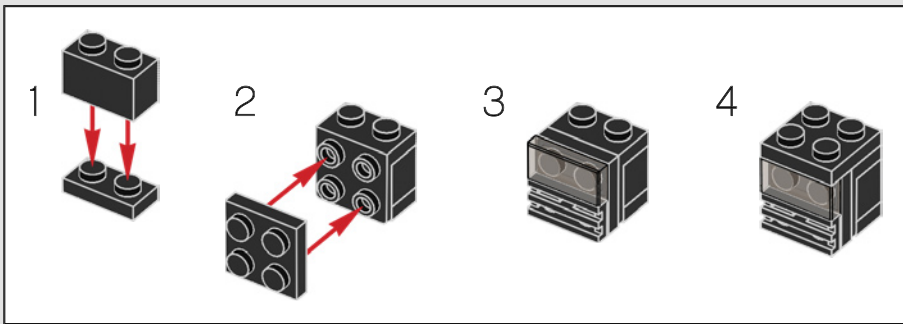

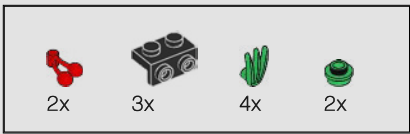

50

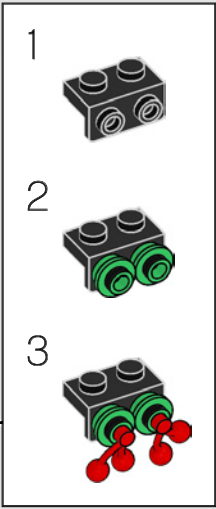
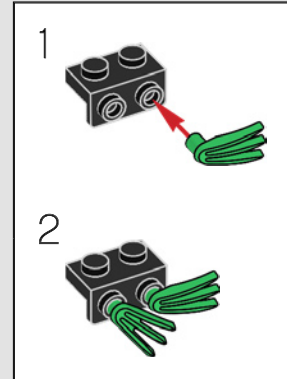
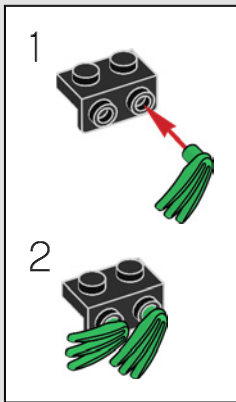

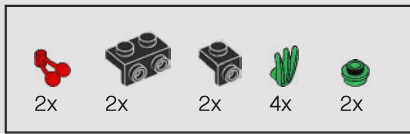

51

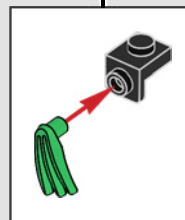
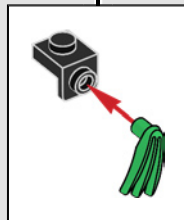
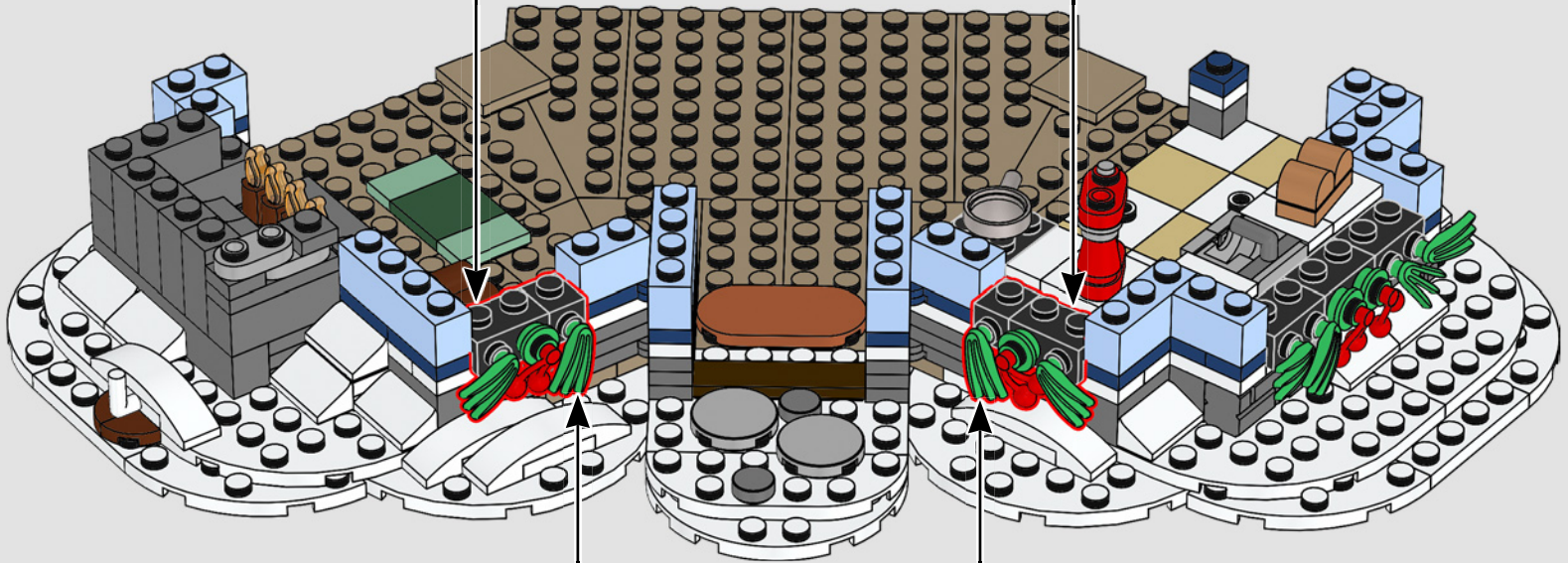
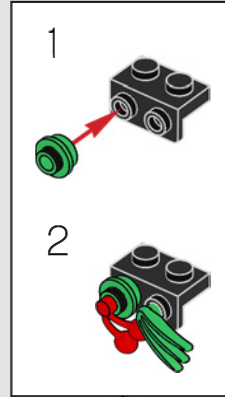
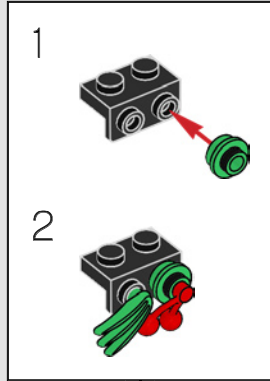

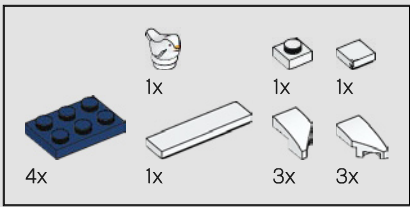

52

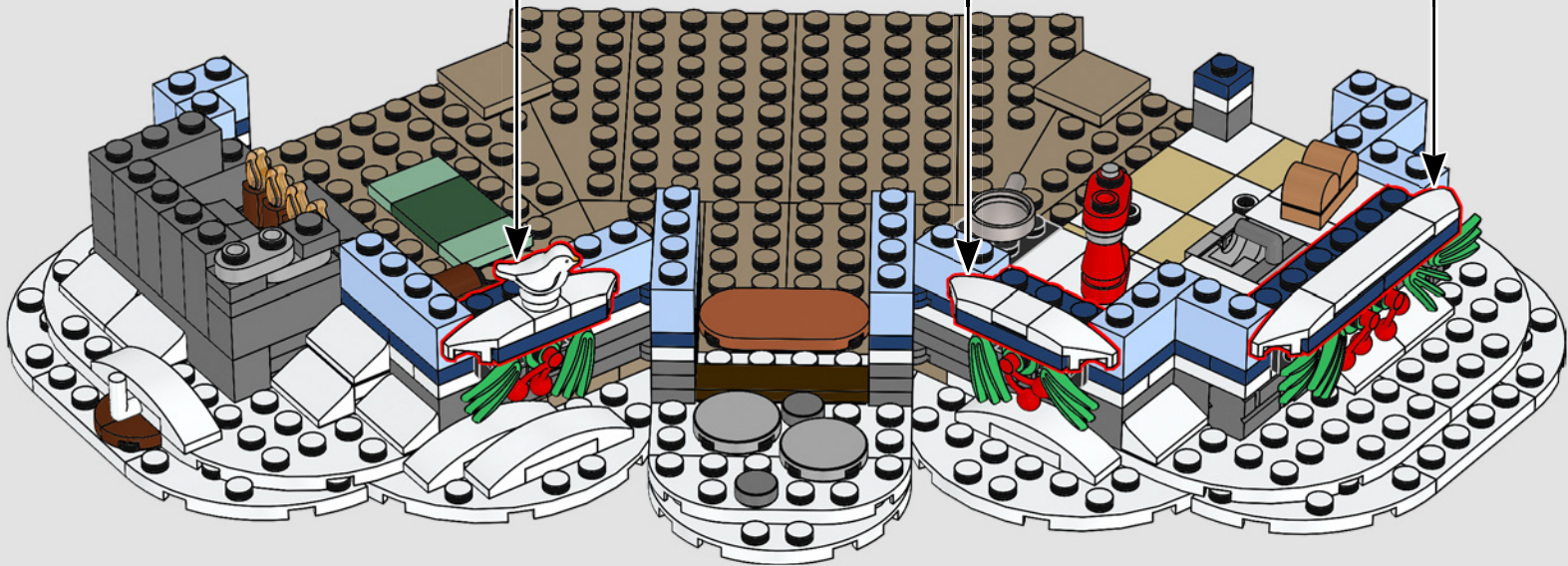
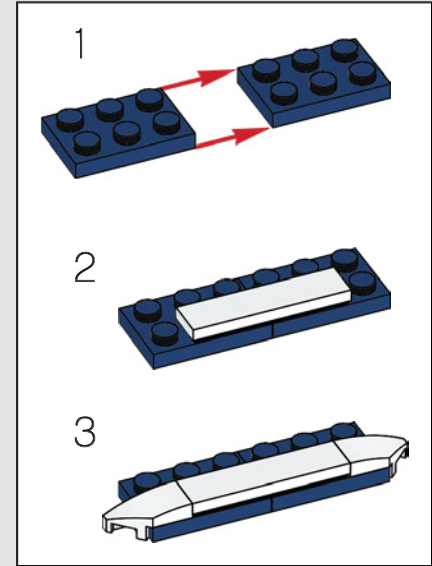
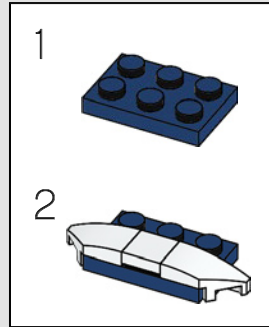
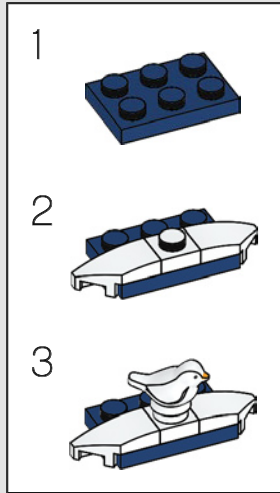

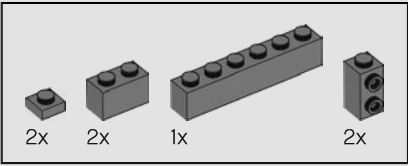
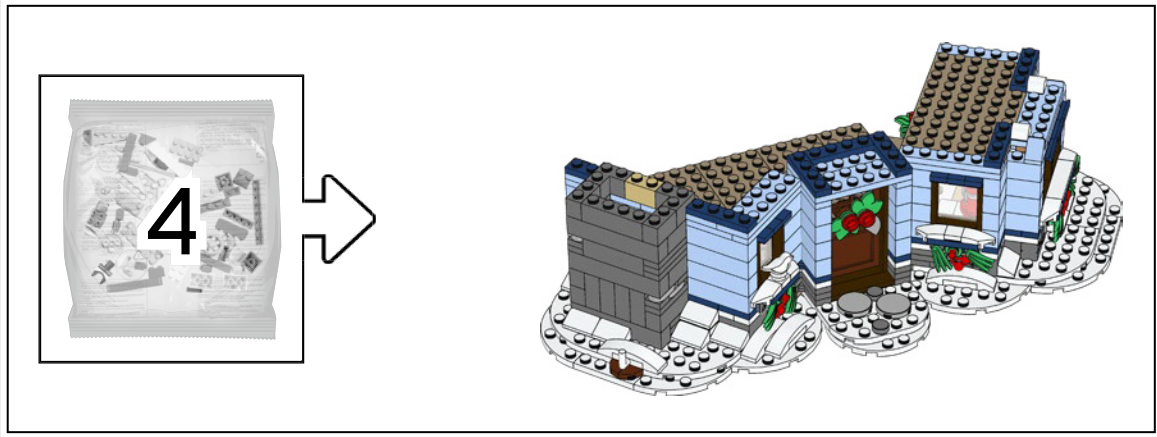

53

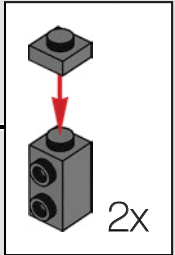

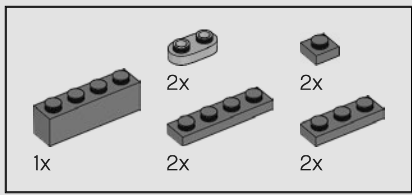

54

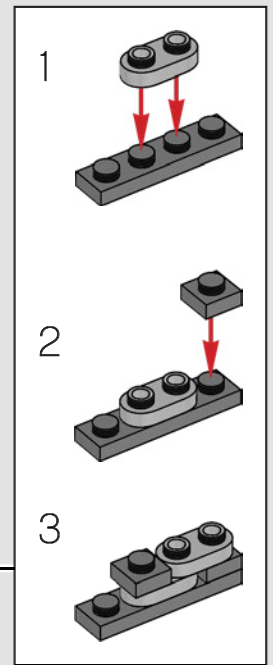
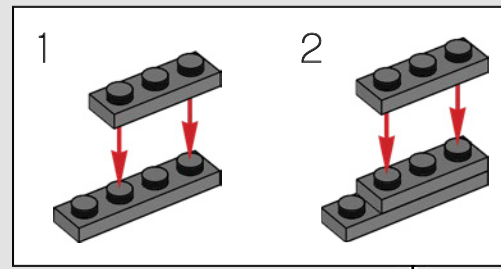

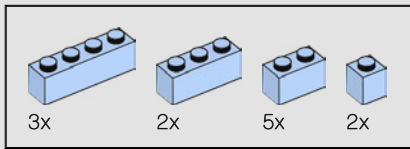

55

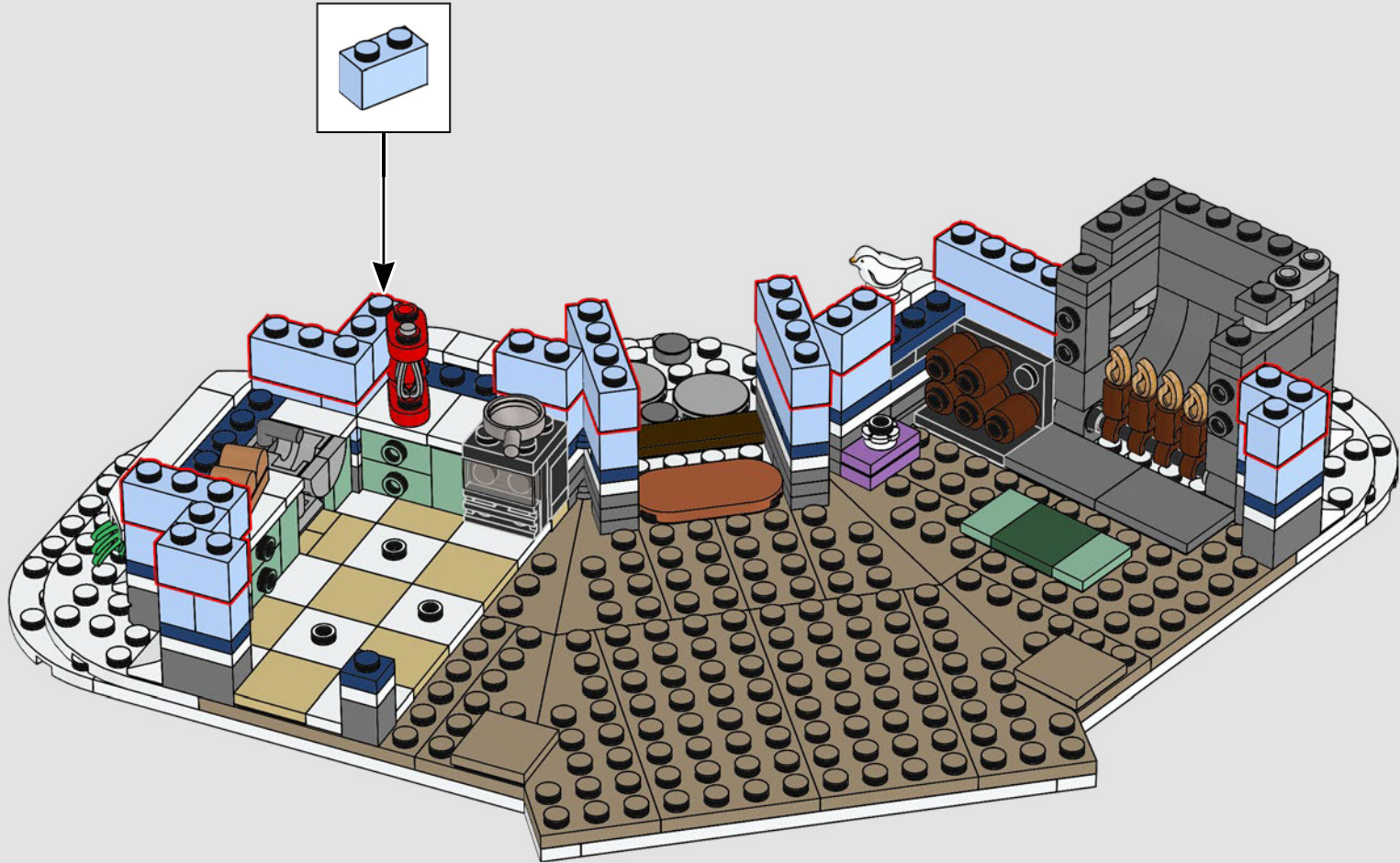

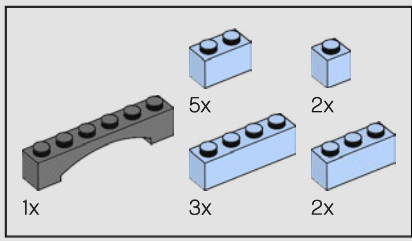

56

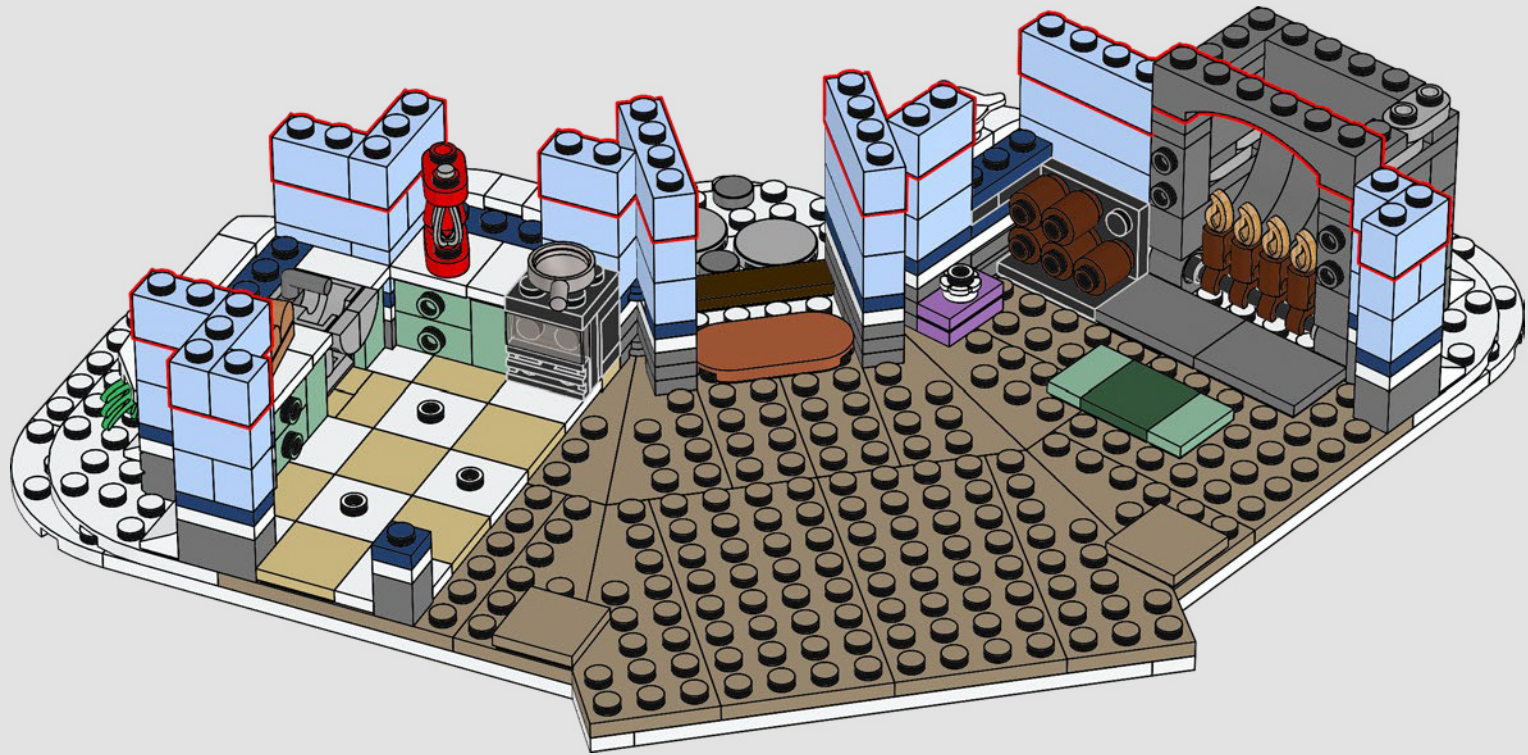

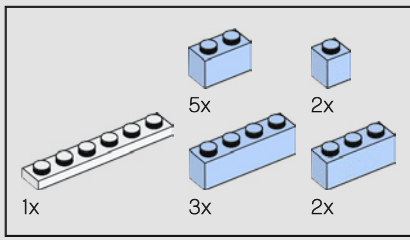

57

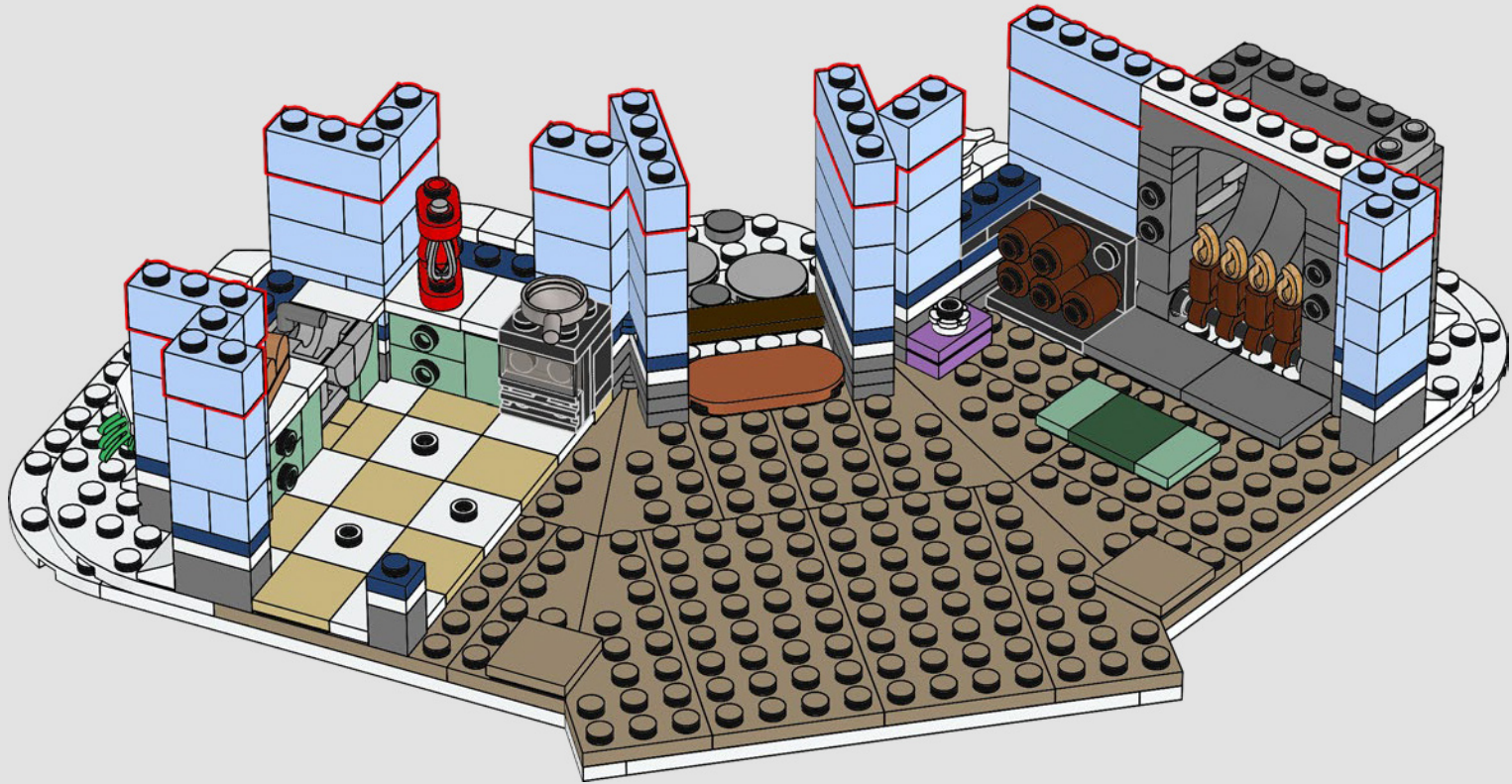

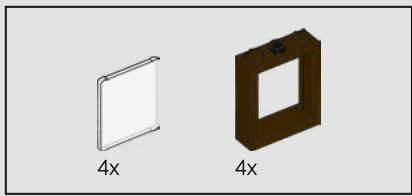

58

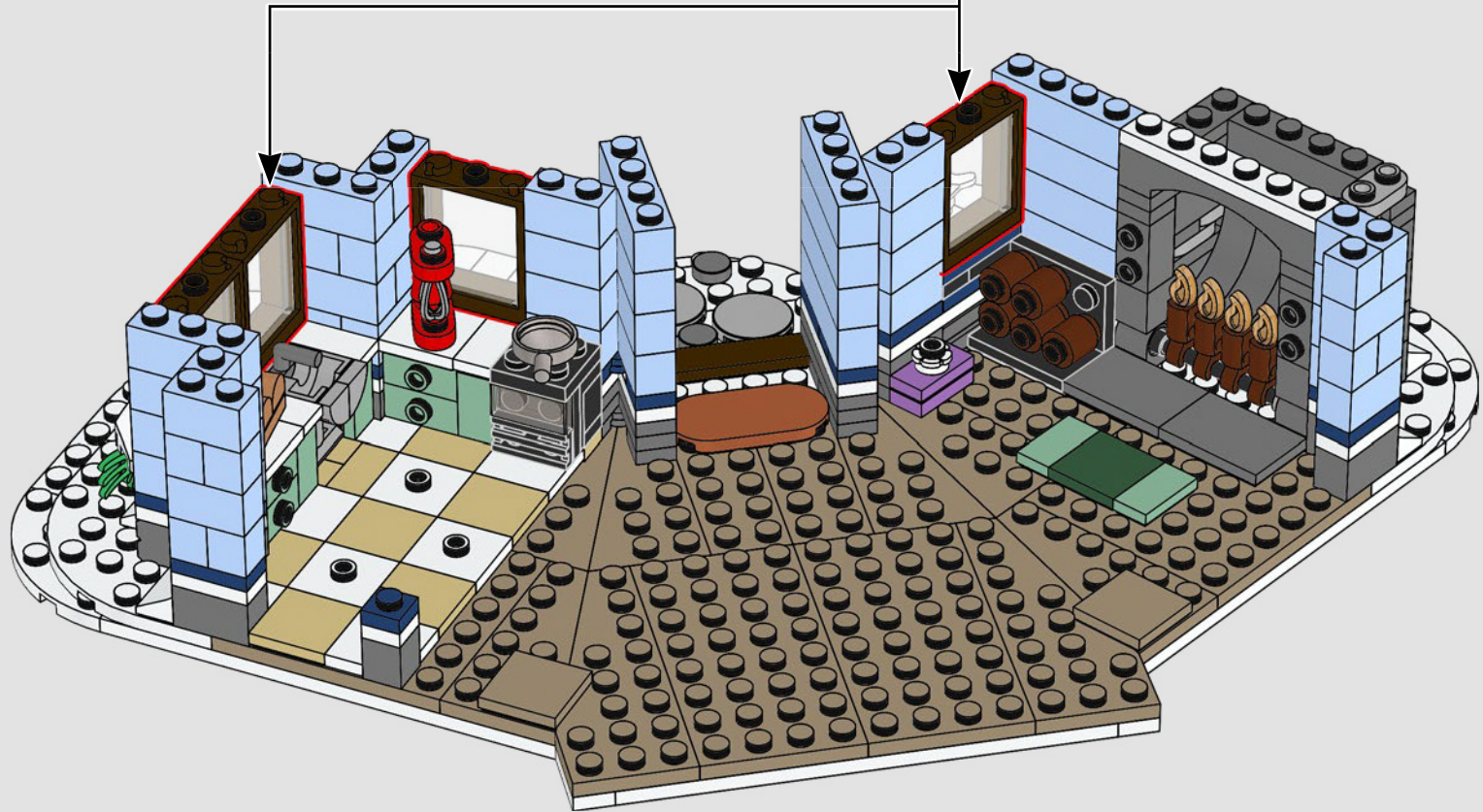
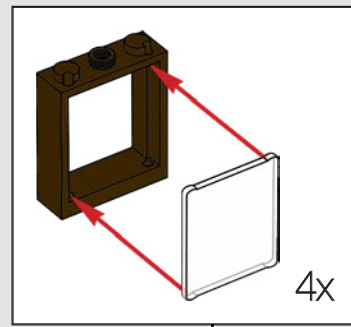

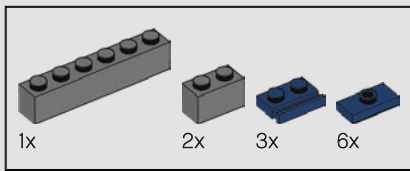

59



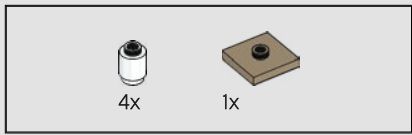

60



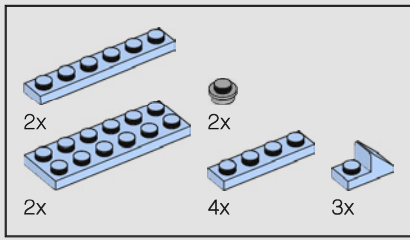

61



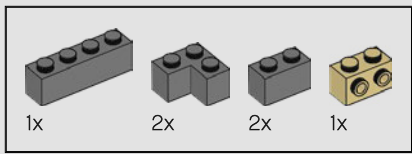

62



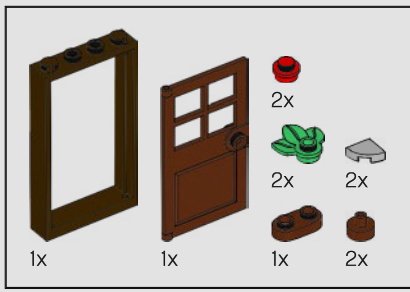

63

1

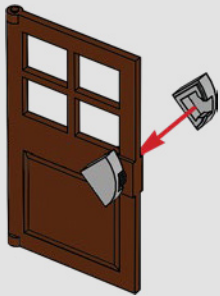

2

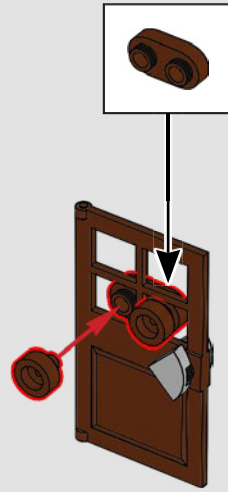

3



4



5

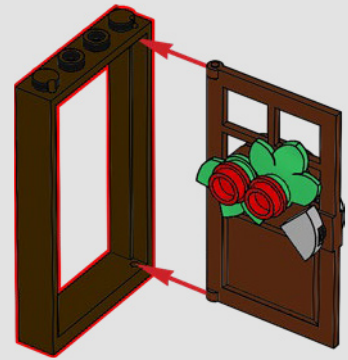

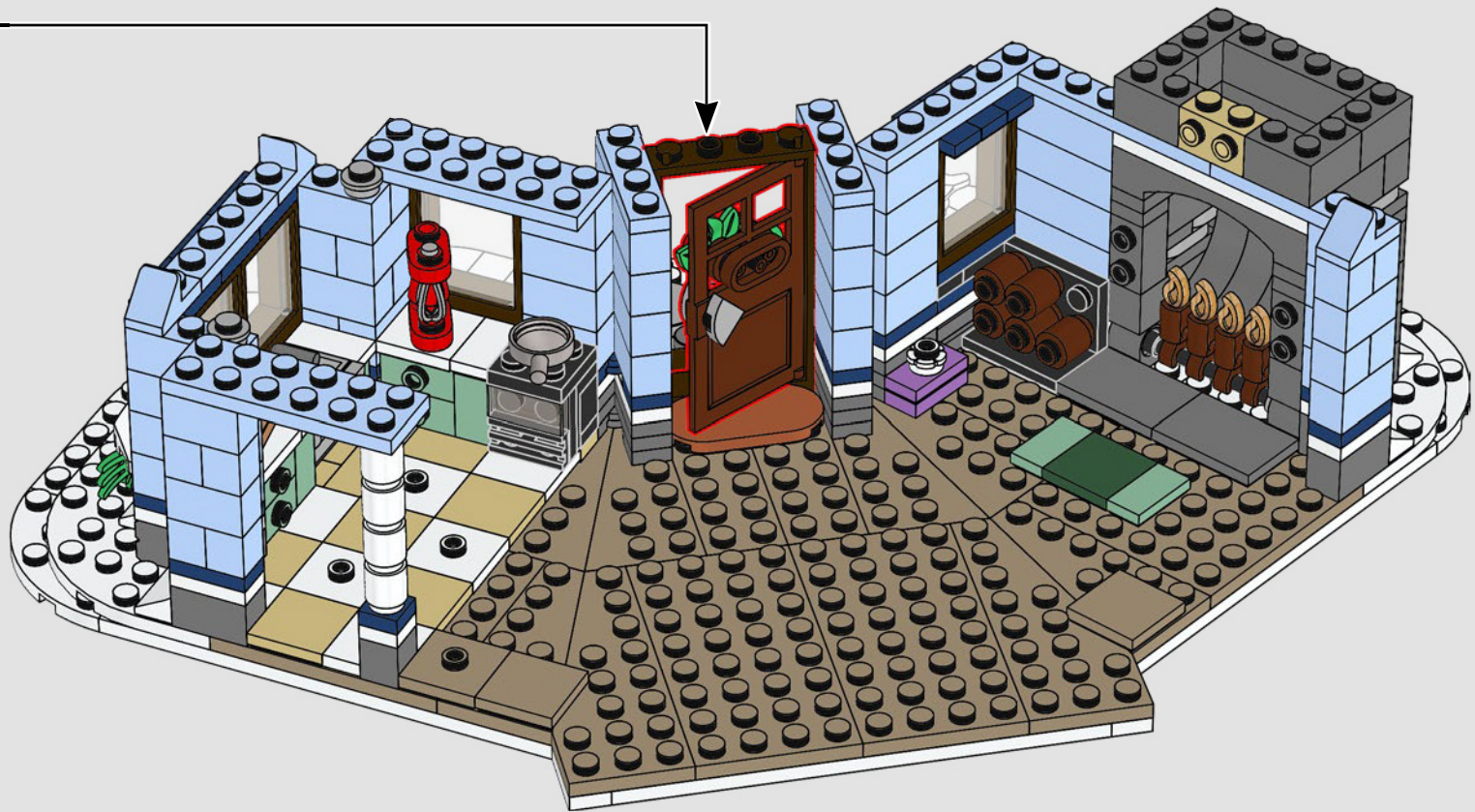

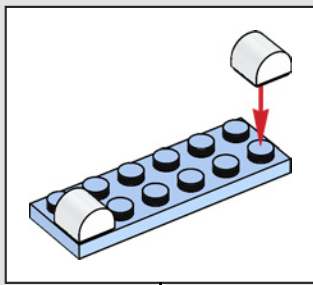
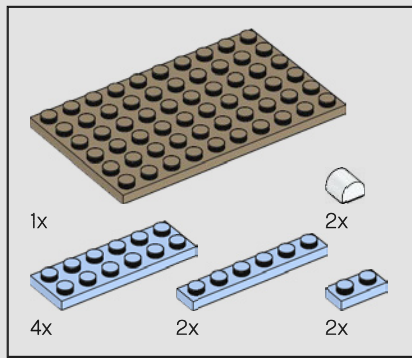

64



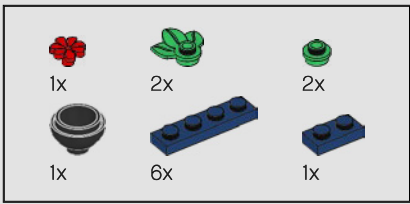

65

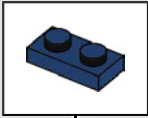
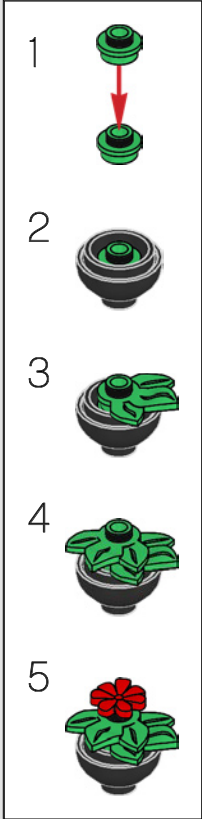

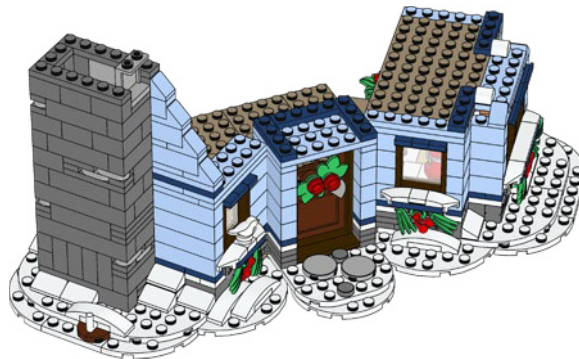

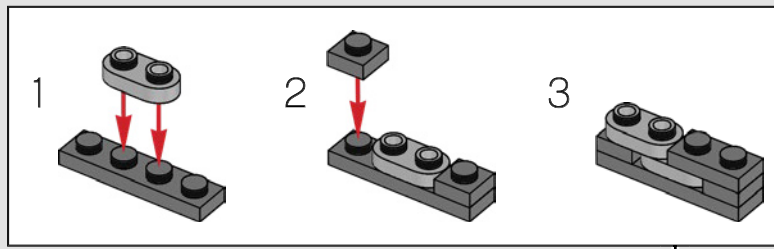
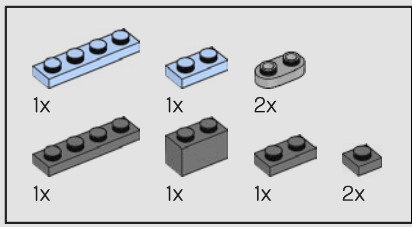

66



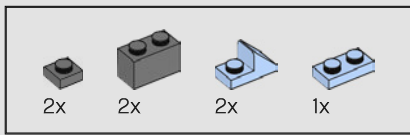

67



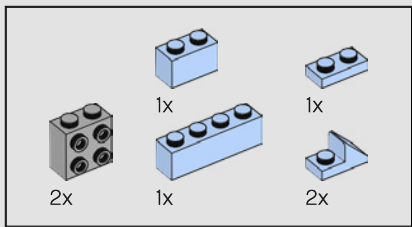

68

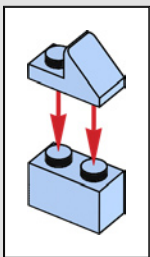
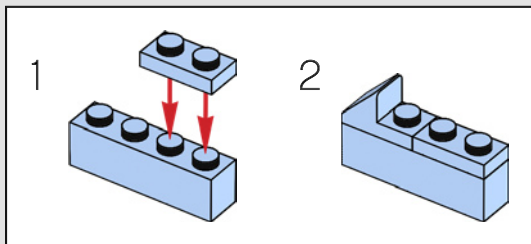

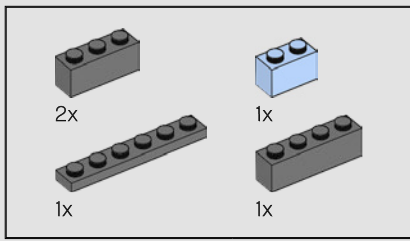

69



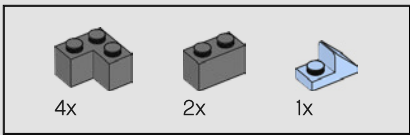

70



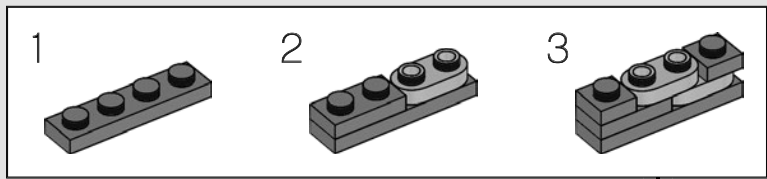
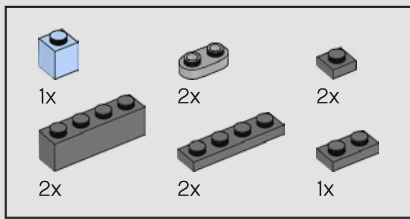

71



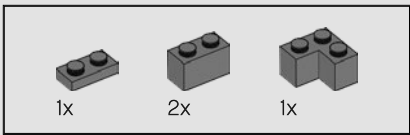

72



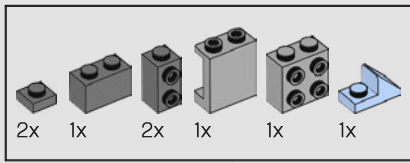

73

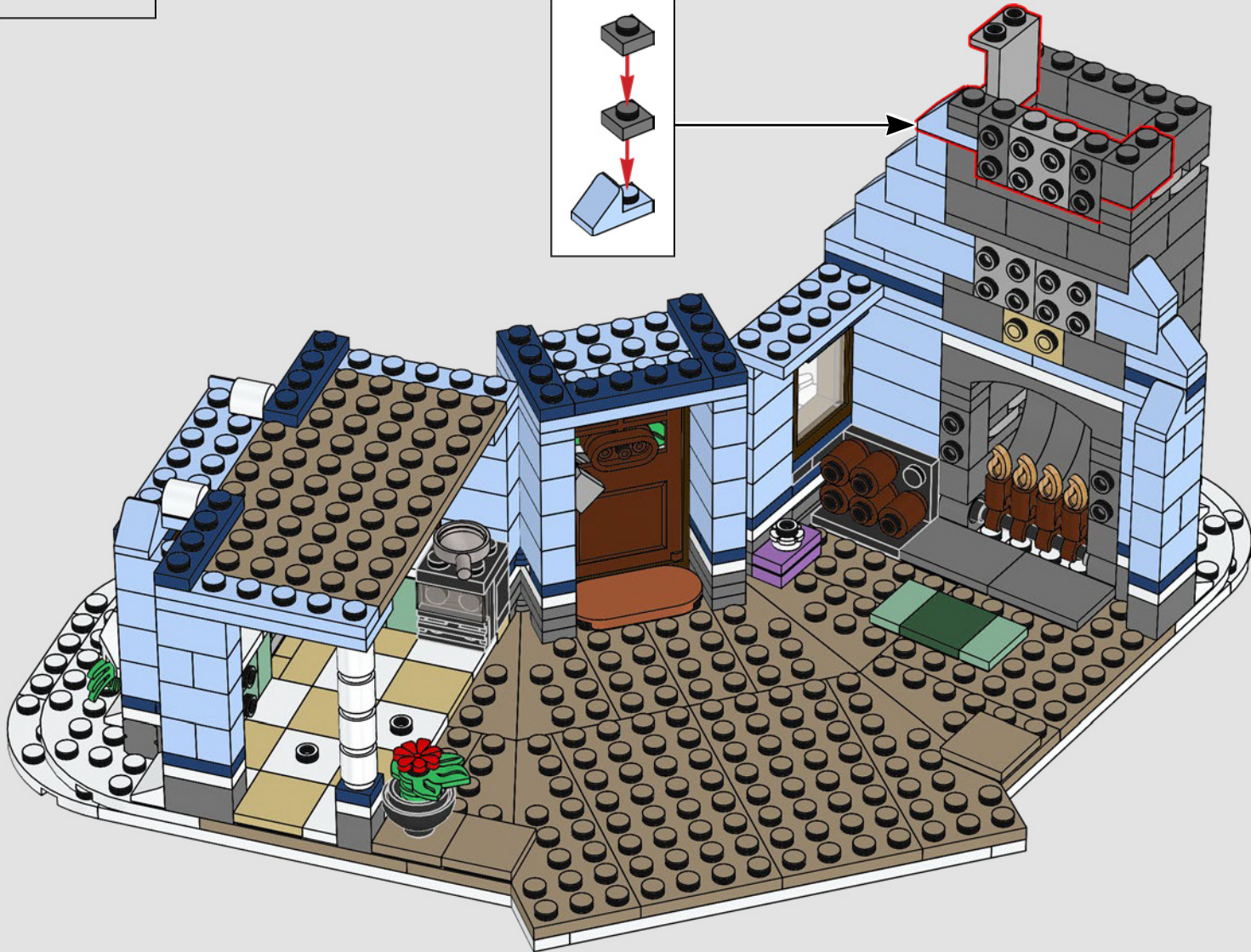
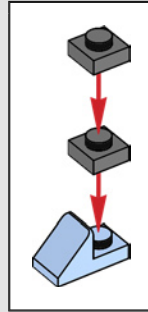

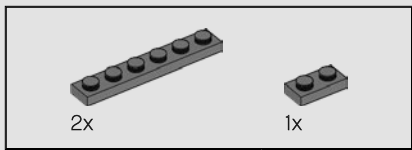

74



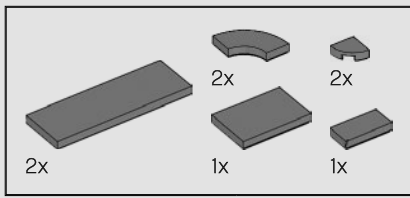

75



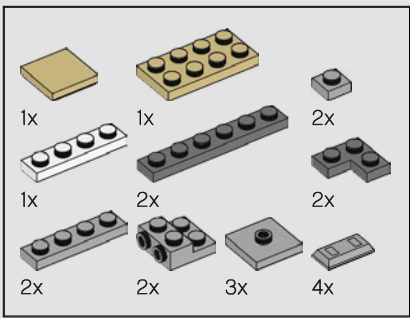

76

1

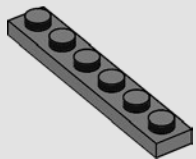

2

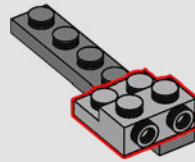

3

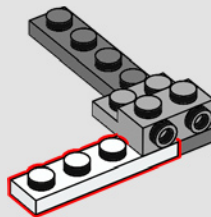

4

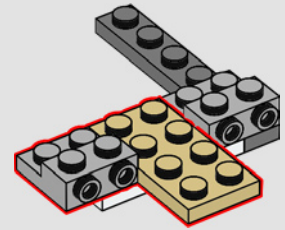

5

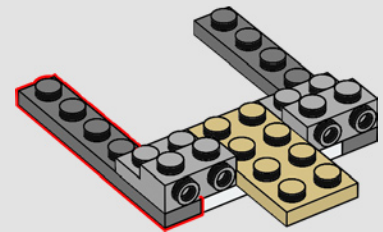

6

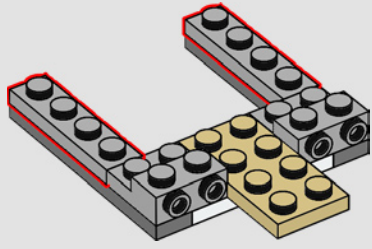

7

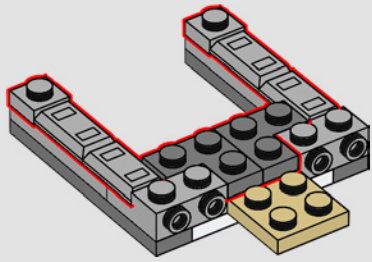

8

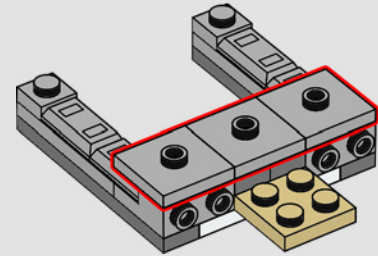

9

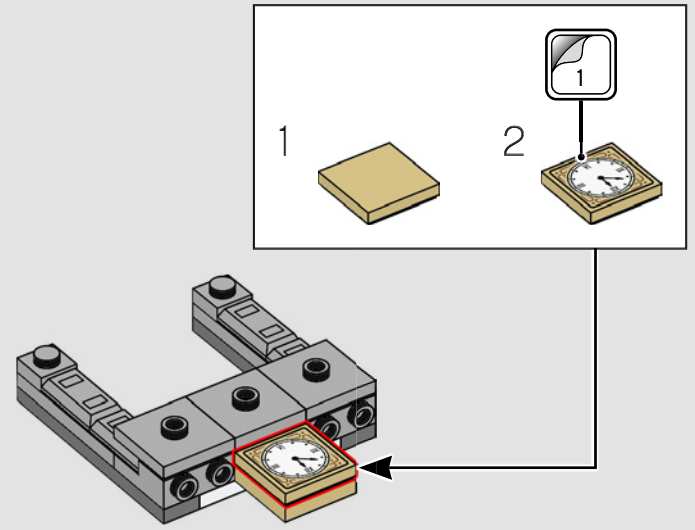



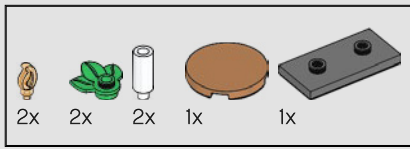

77

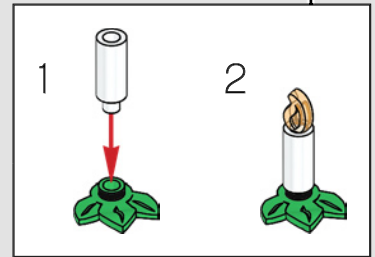
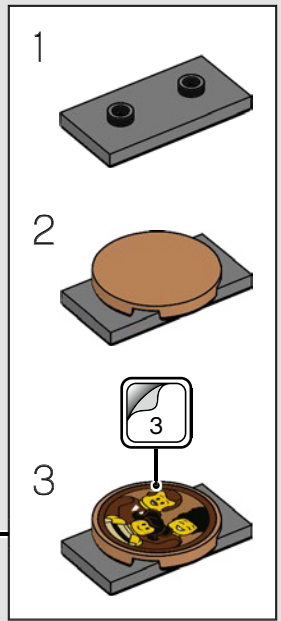
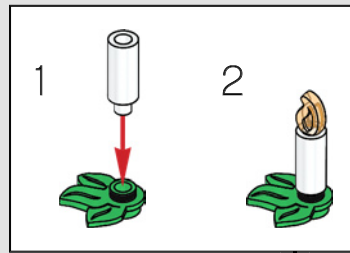

- 1x
- 1x
- 1x
- 1x
- 1x
- 1x
- 1x
- 2x
- 2x
- 1x
- 1x
- 1x

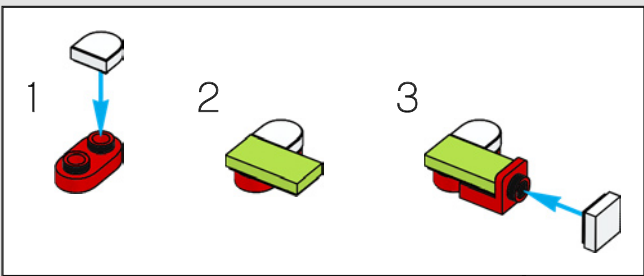

78

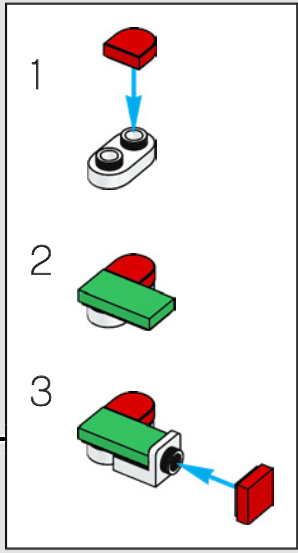
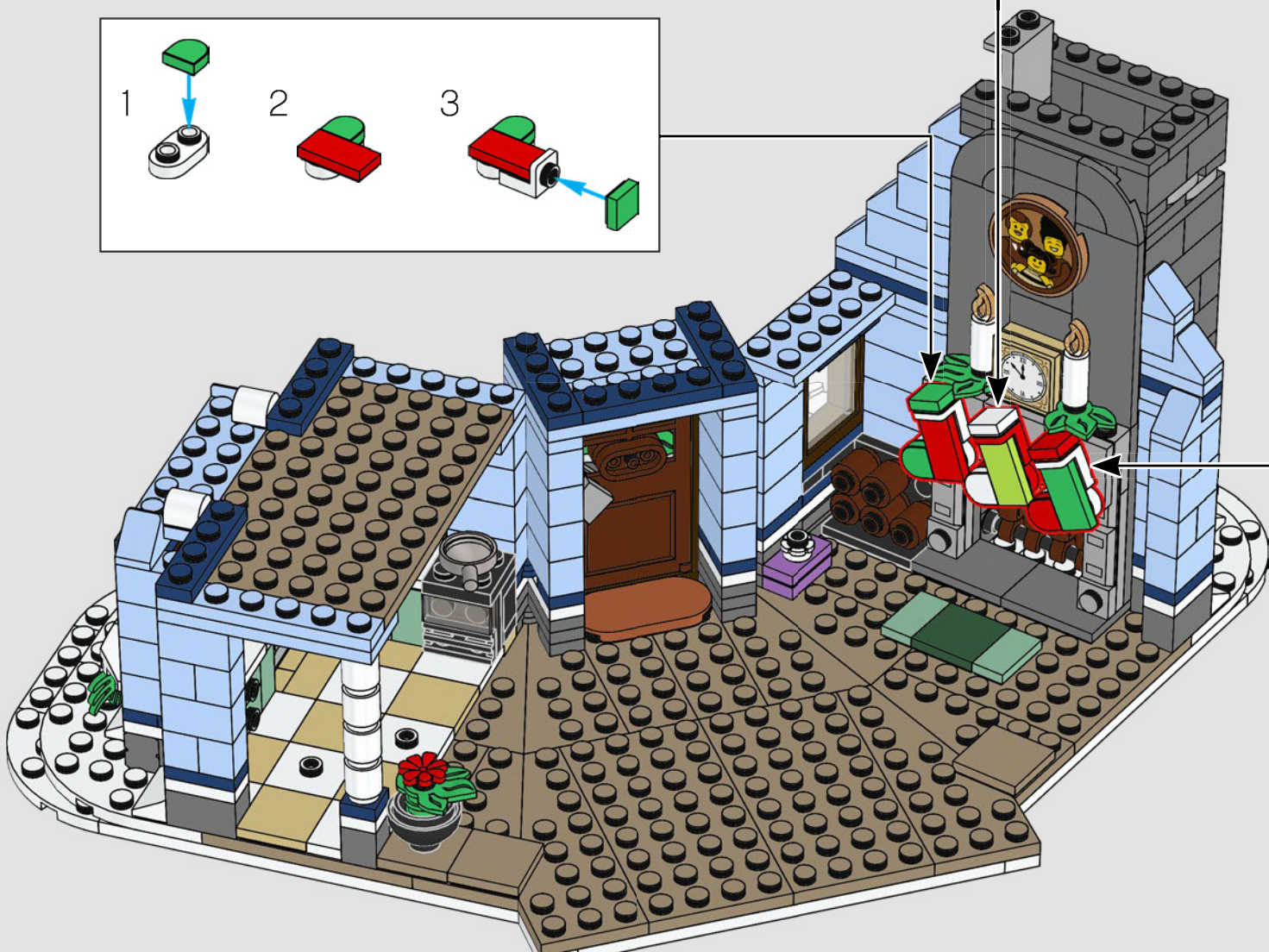
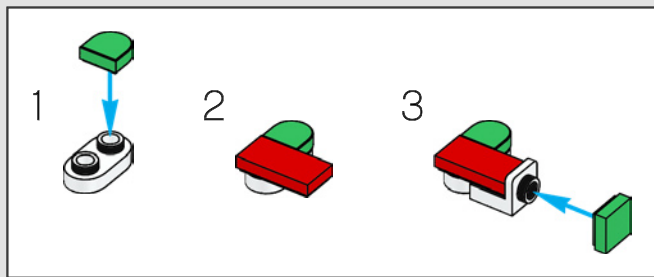

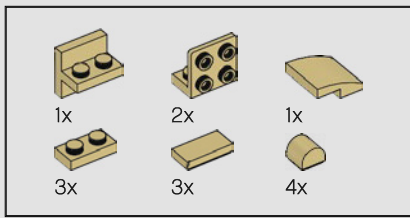

79

1

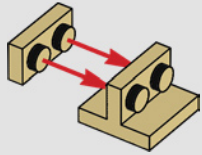

2

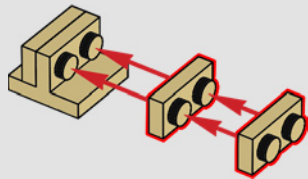

3

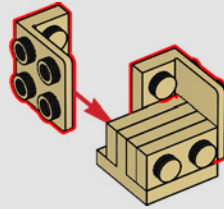

4

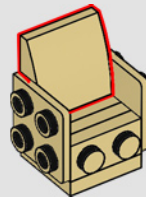

5

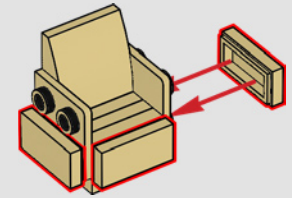

6

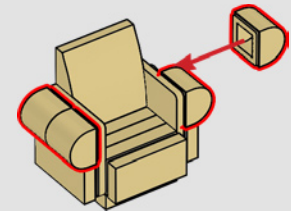

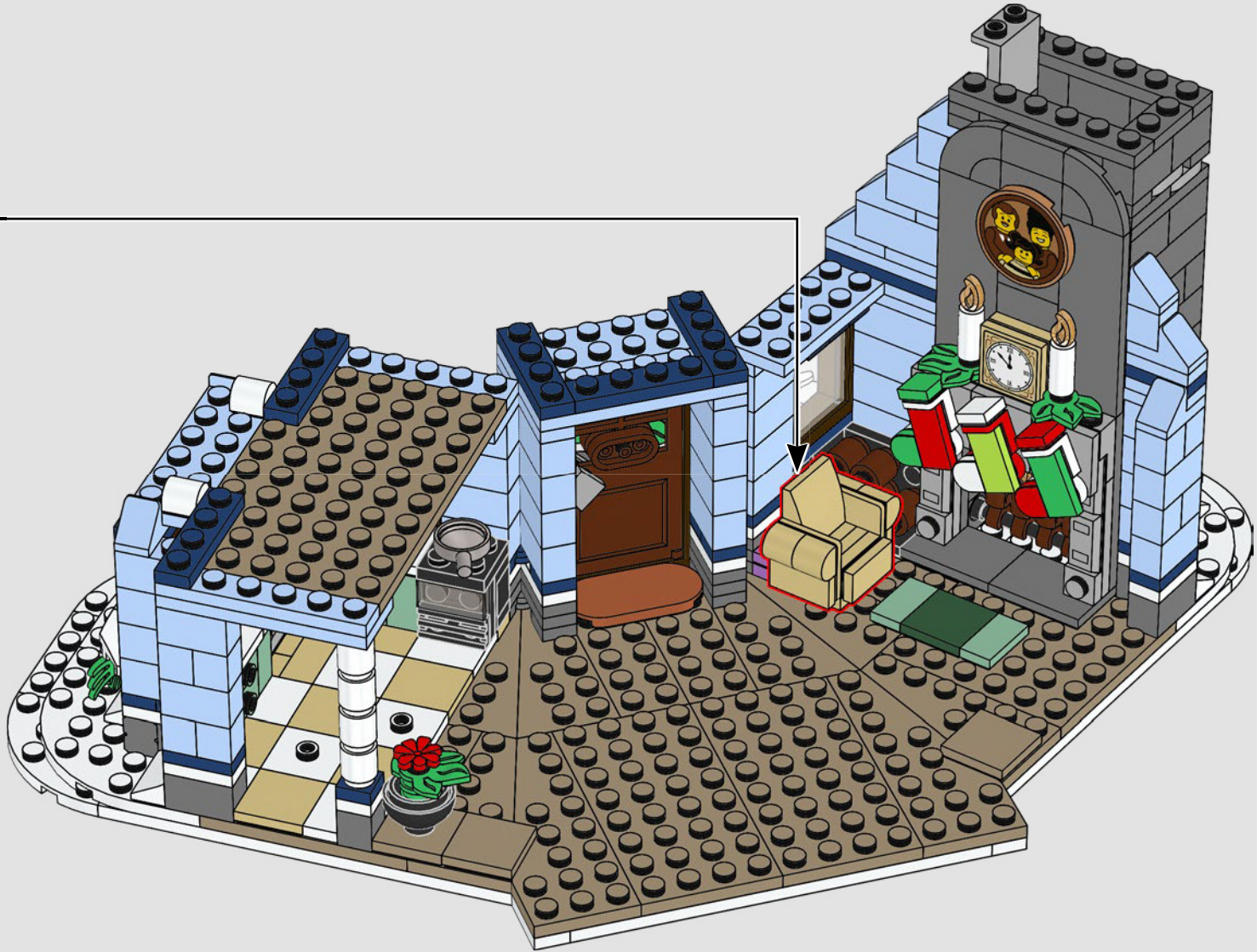

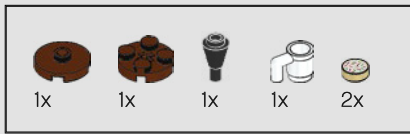

80

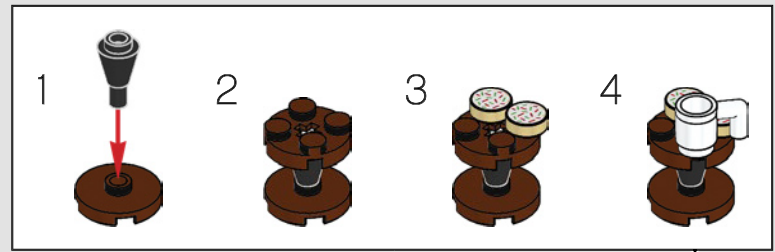

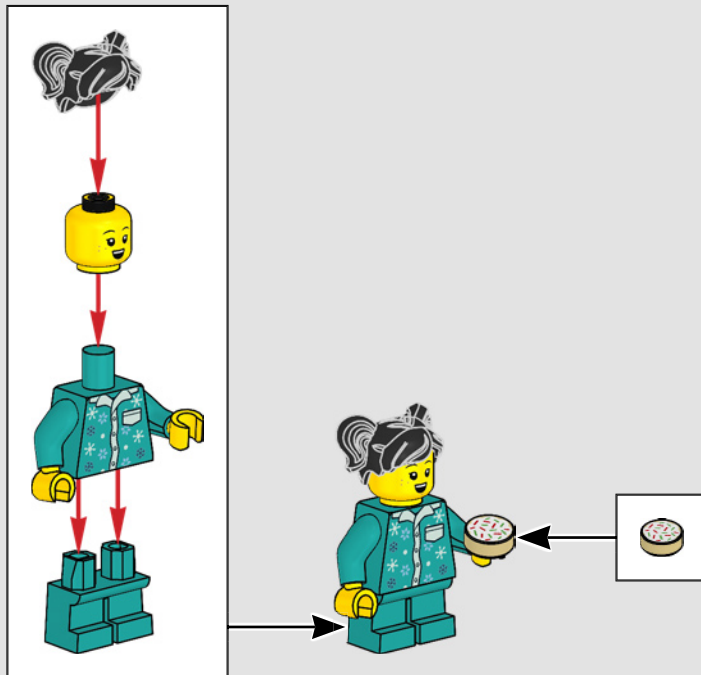
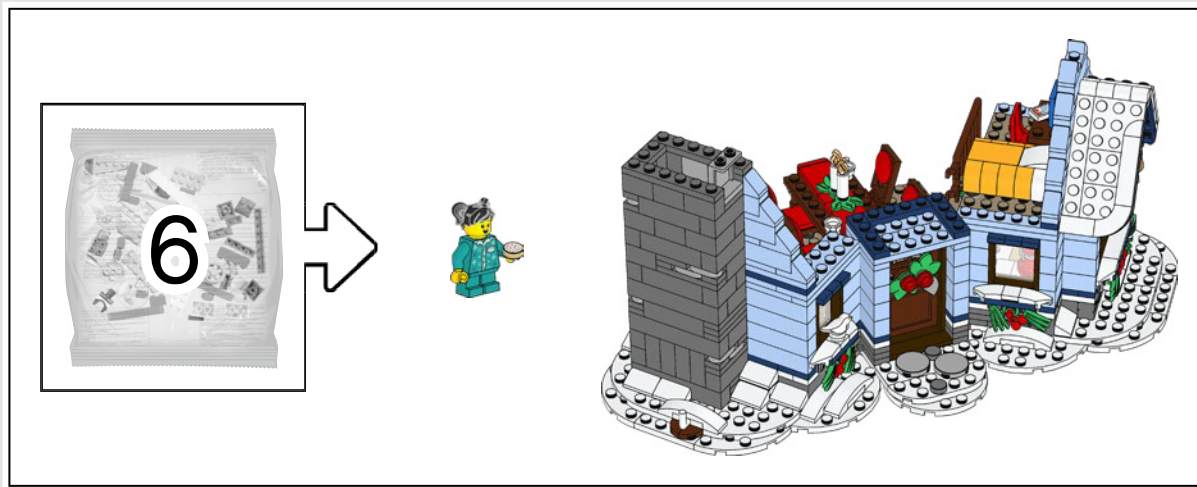

Dem Weihnachtsplätzchen dienen
„Schmelzende Momente“ als Vorbild. So nennt
die Mutter des LEGO® Designers die Plätzchen,
die sie immer an Weihnachten backt.

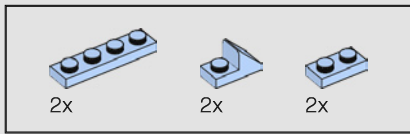

81

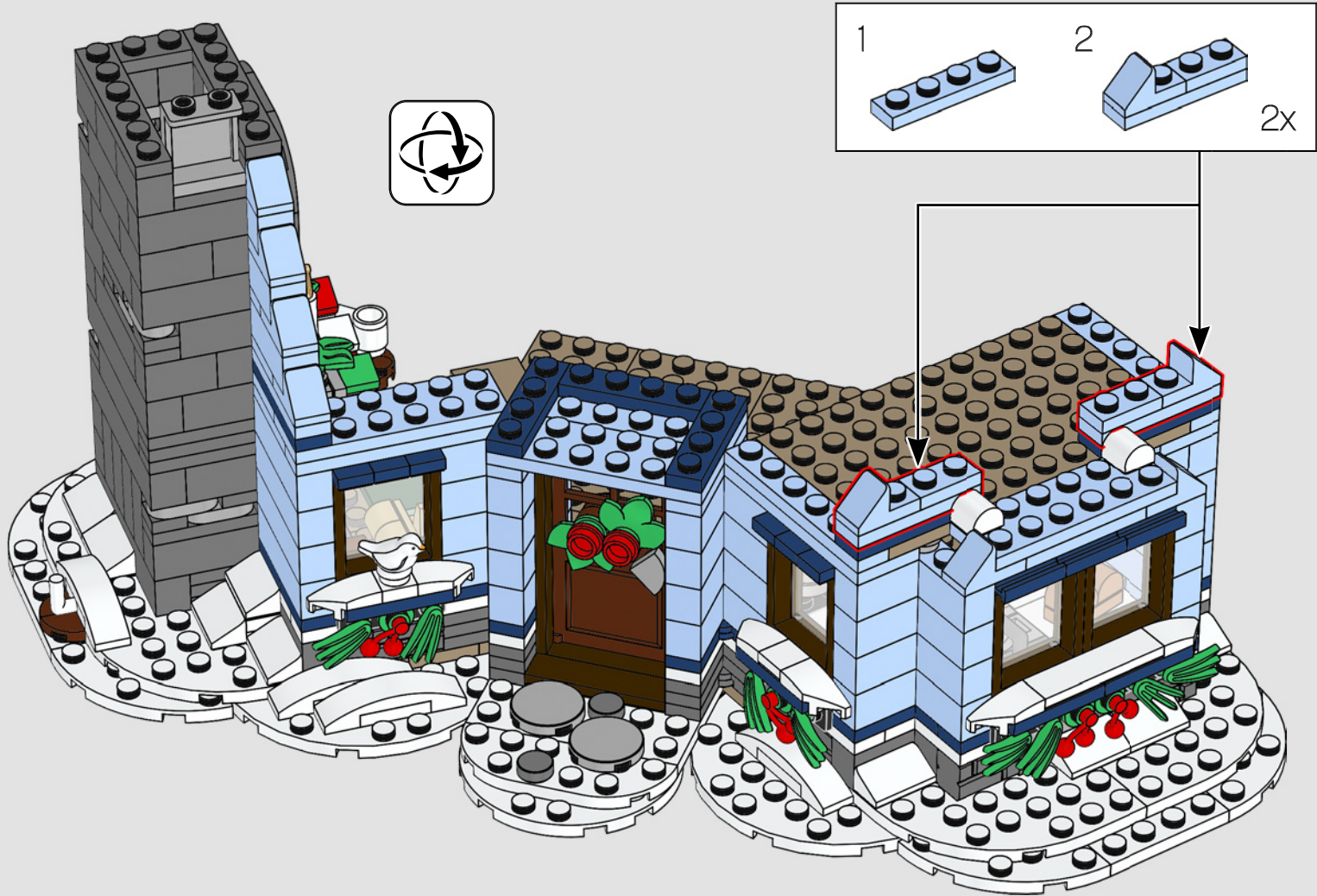

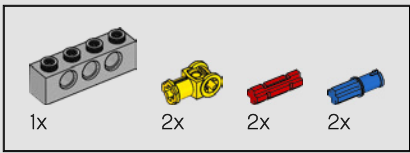

82

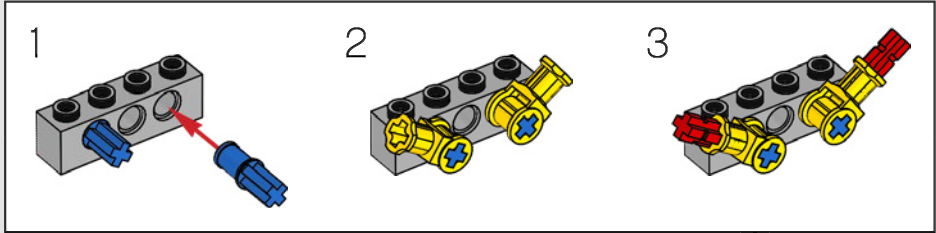

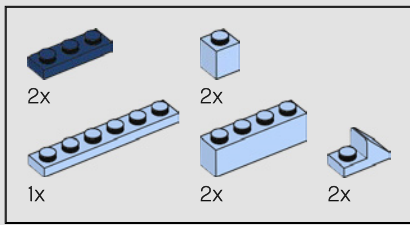

83

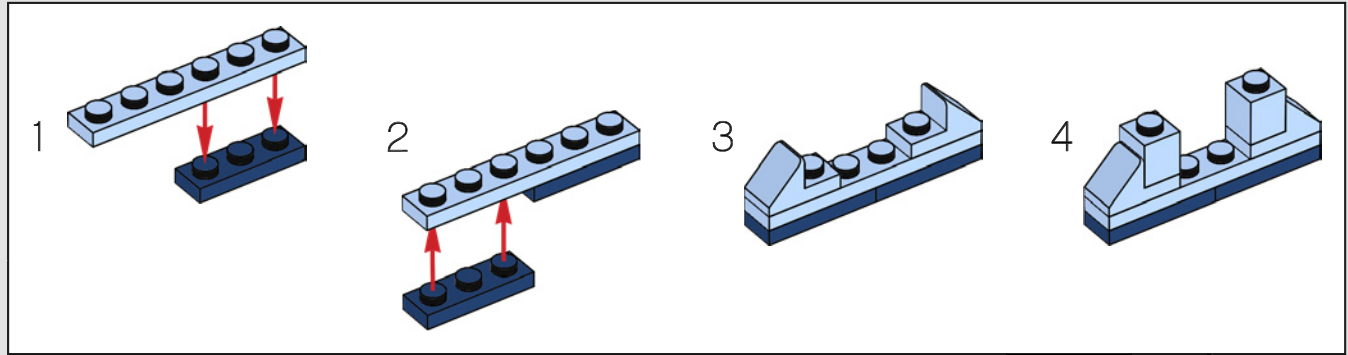

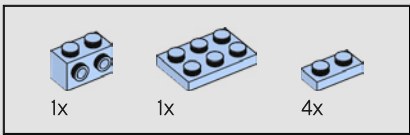

84

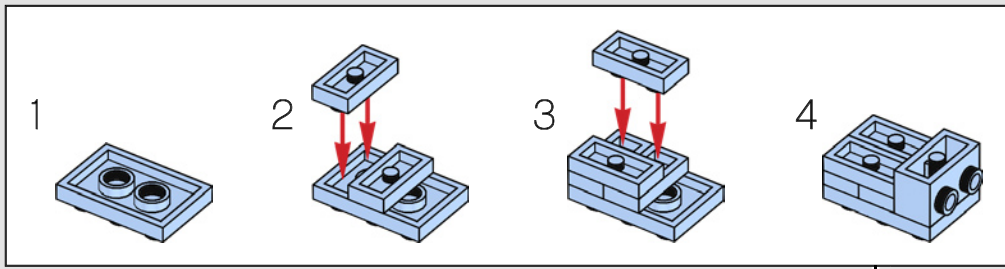

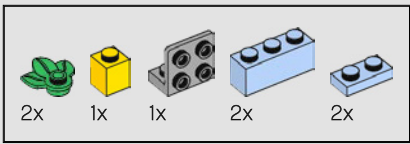

86



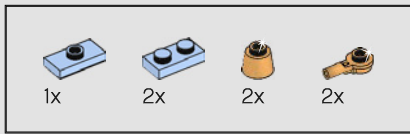

87



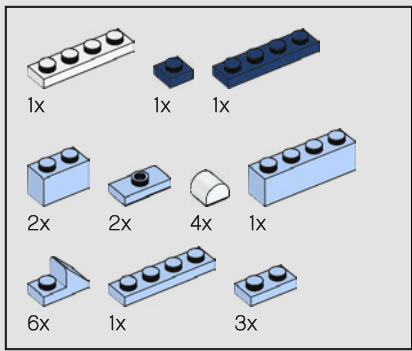

88

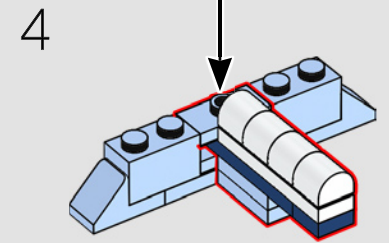
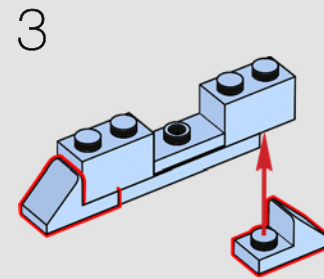
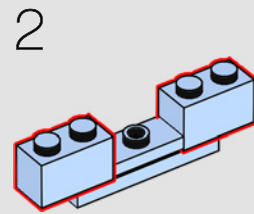
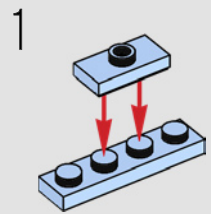
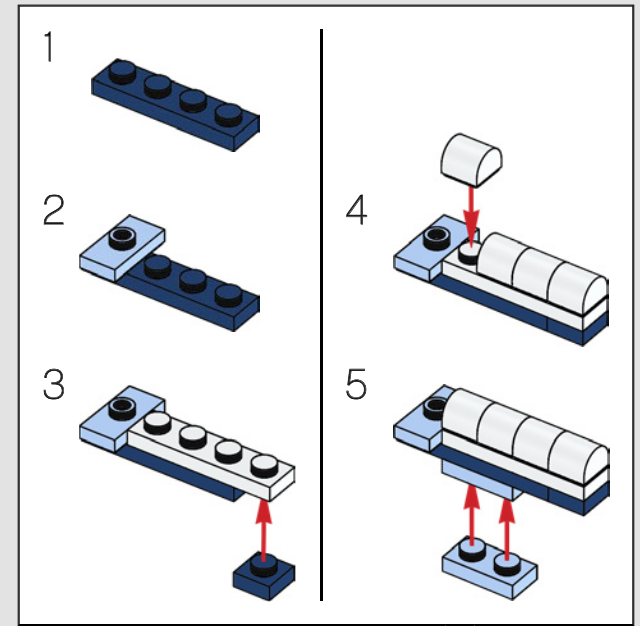

5

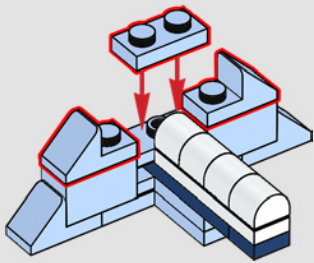

6

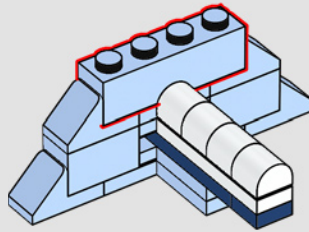

7

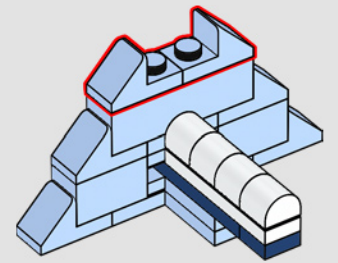



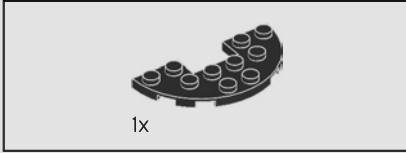
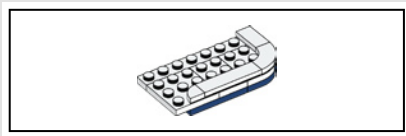

89

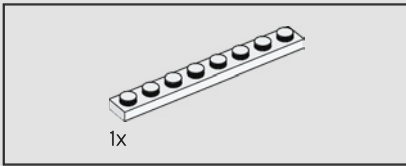

90

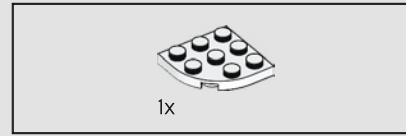
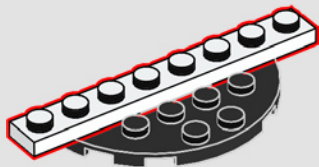

91

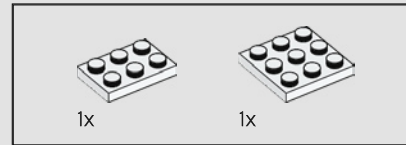
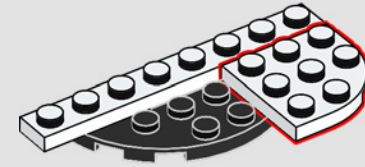

92

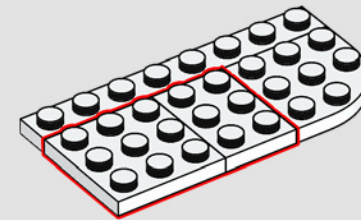

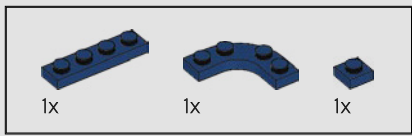

93

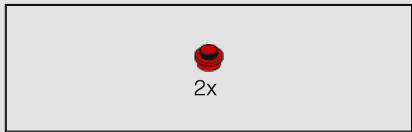
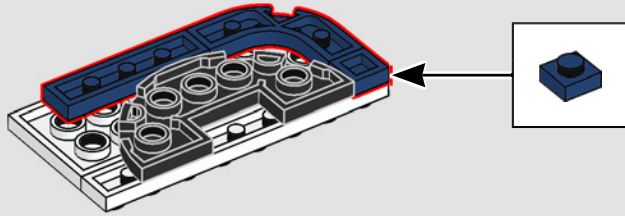

94

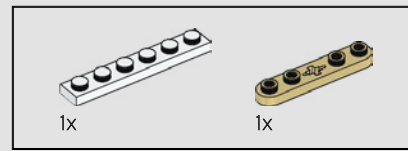
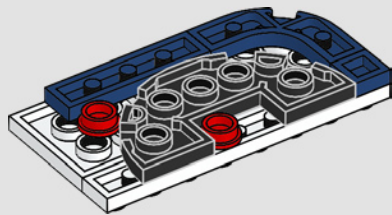

95

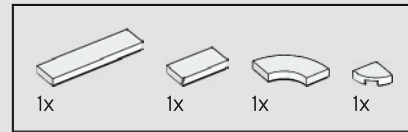
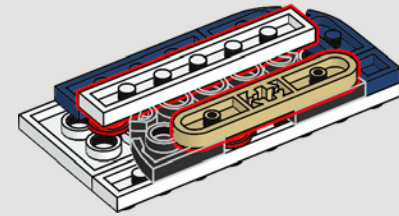

96

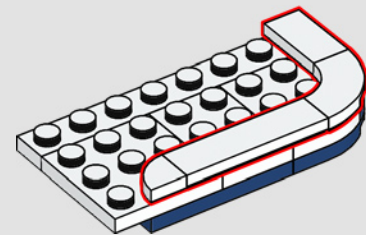
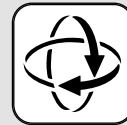



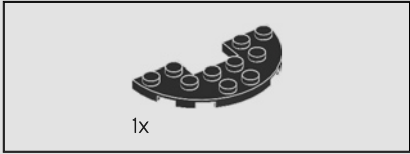
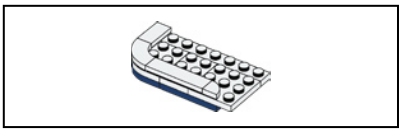

98

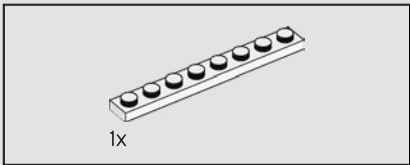

99

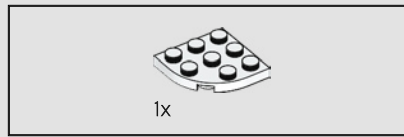
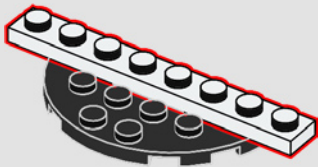

100

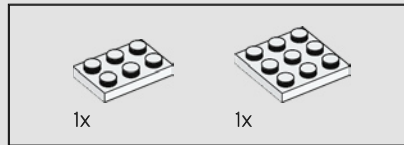
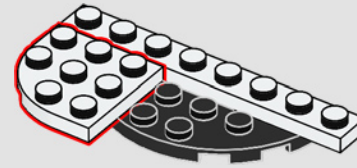

101

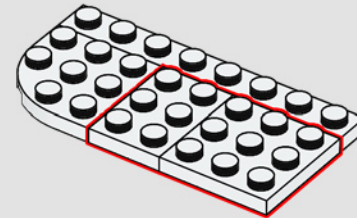

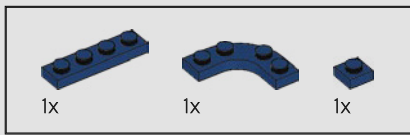

102

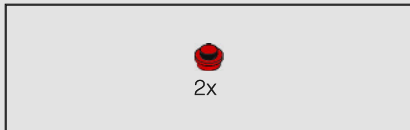
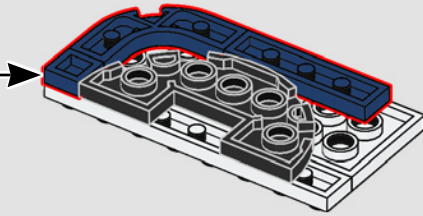
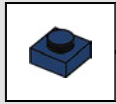

103

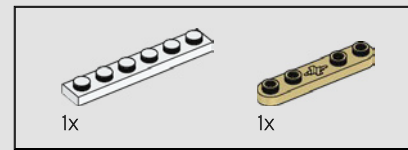
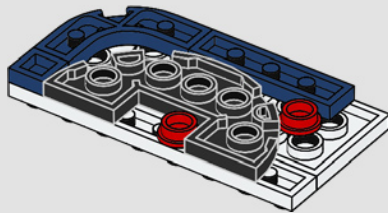

104

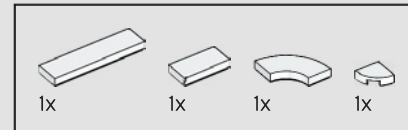
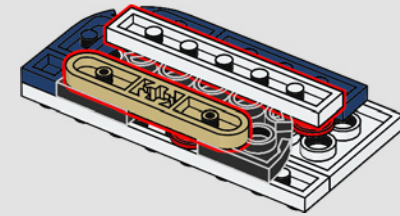

105

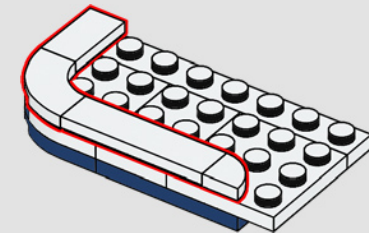
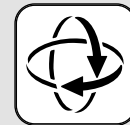



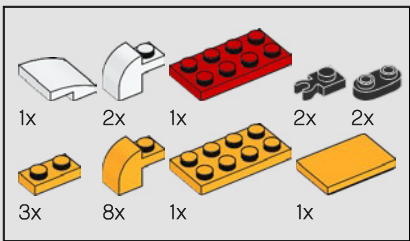

108

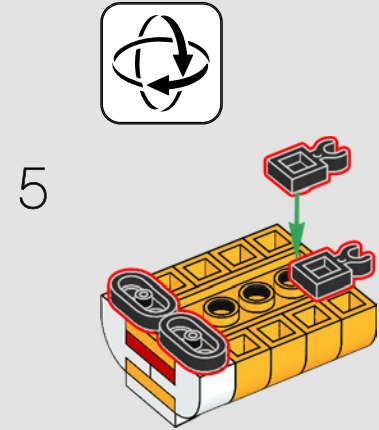
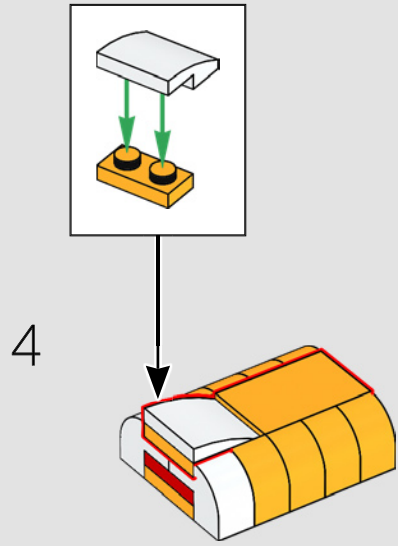
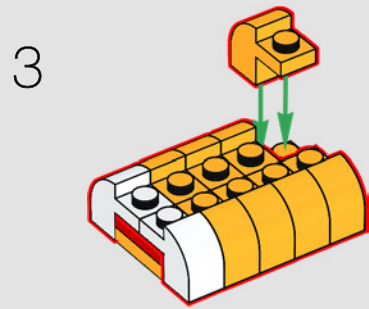
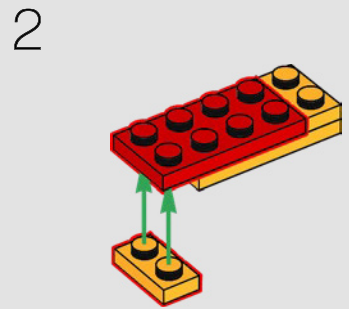
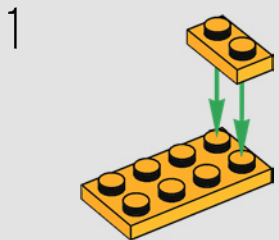



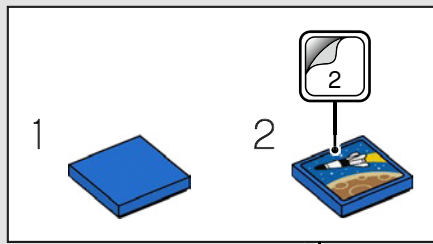
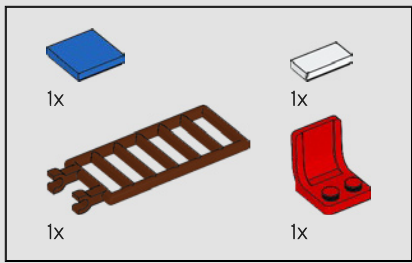

109

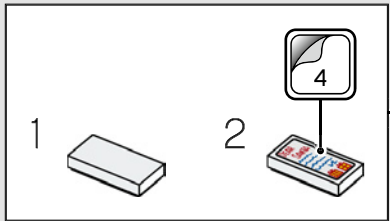

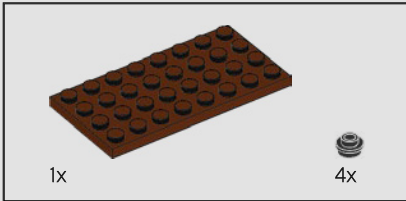

110

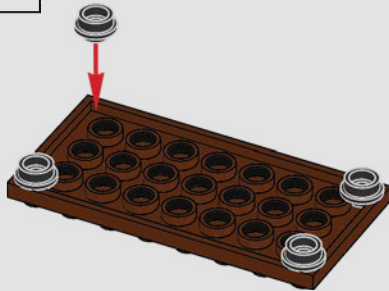

111

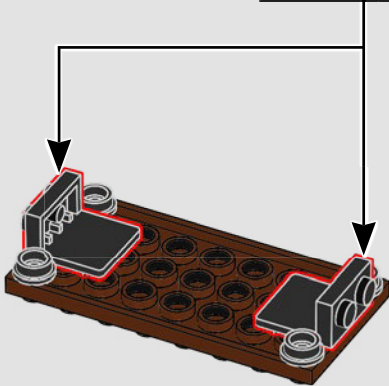
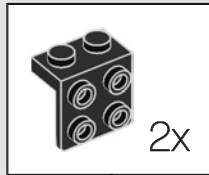

112

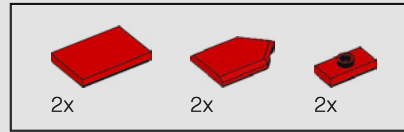
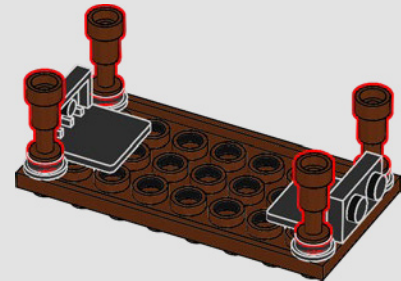

113

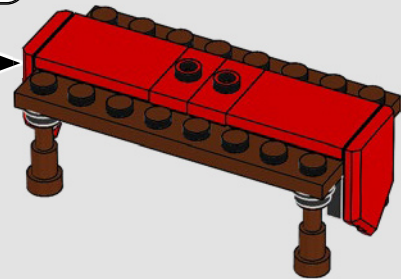
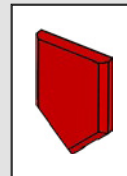
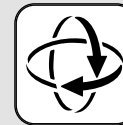

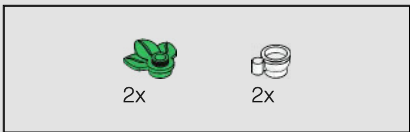

114

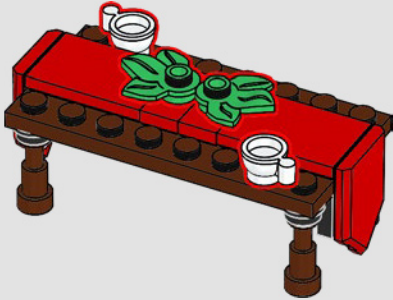

115

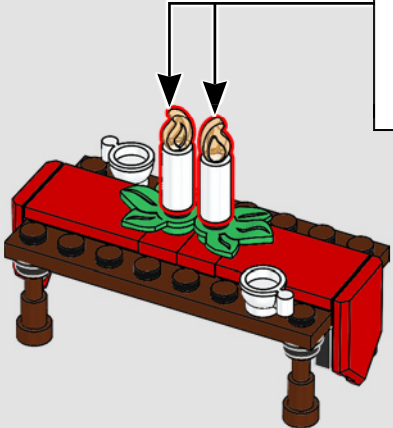
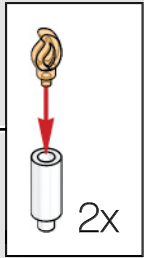

116



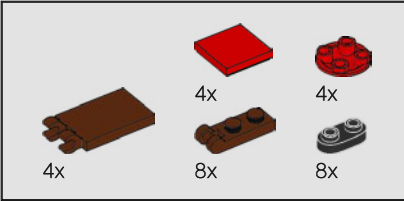

117

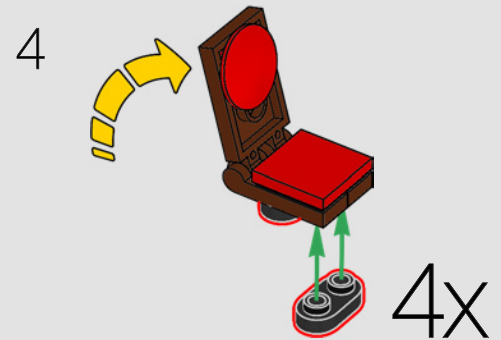
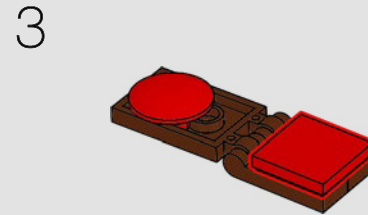
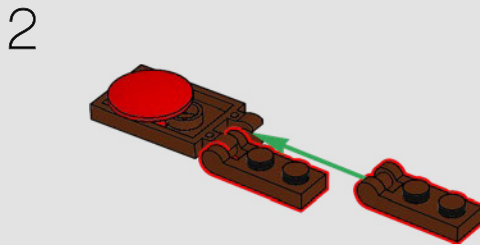
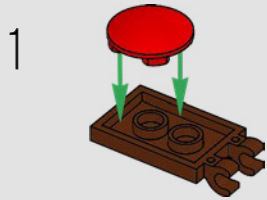



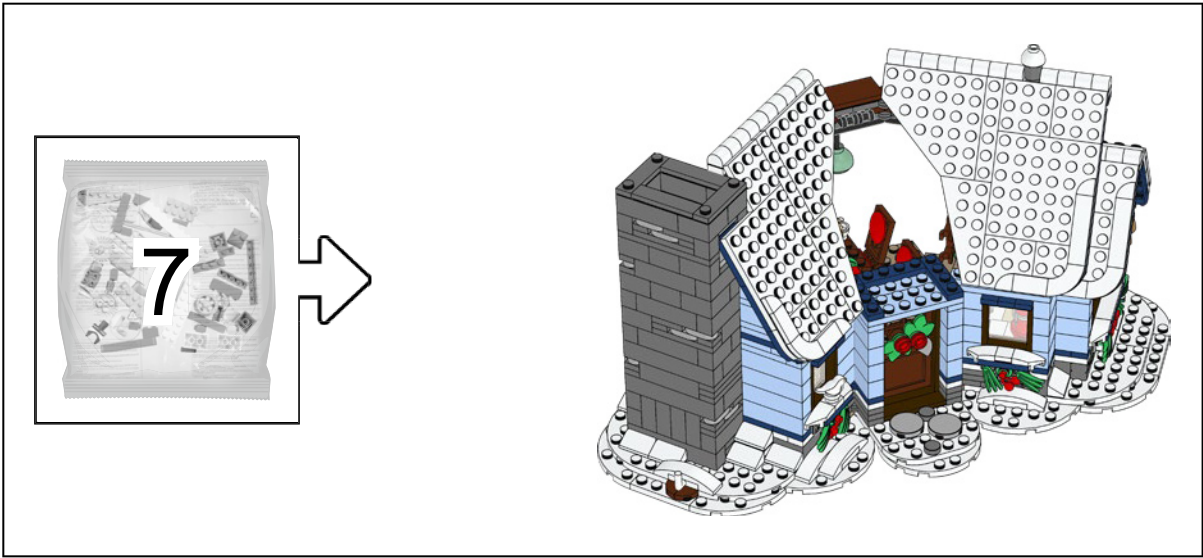

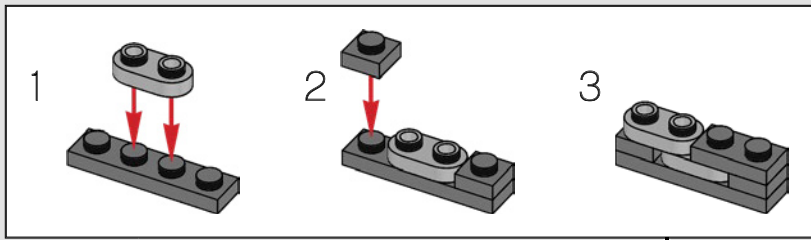
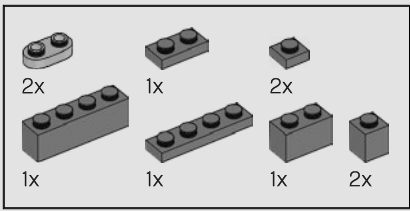

118



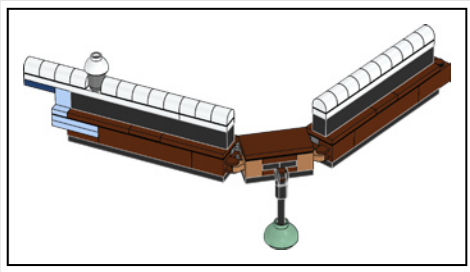

119

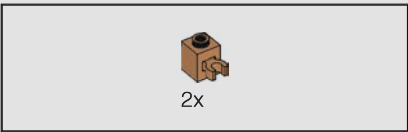
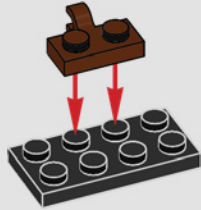

120

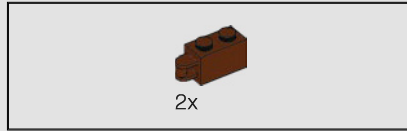
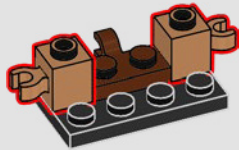

121

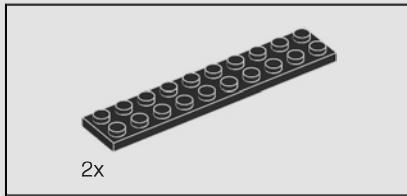
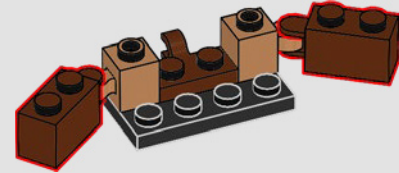

122

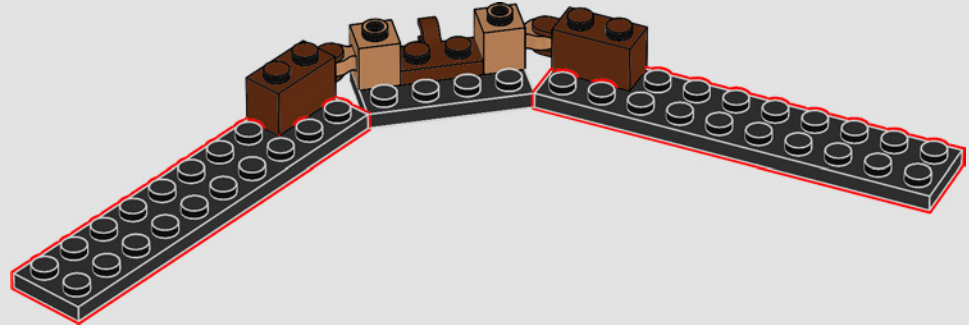

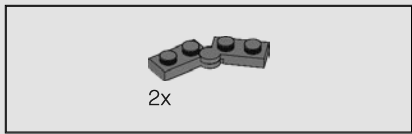

123

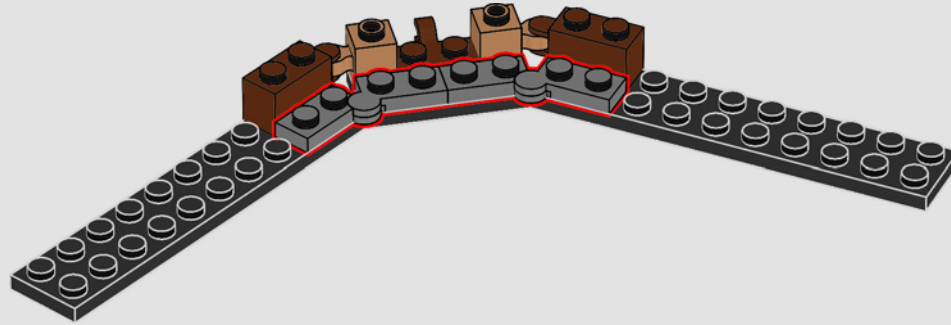

124

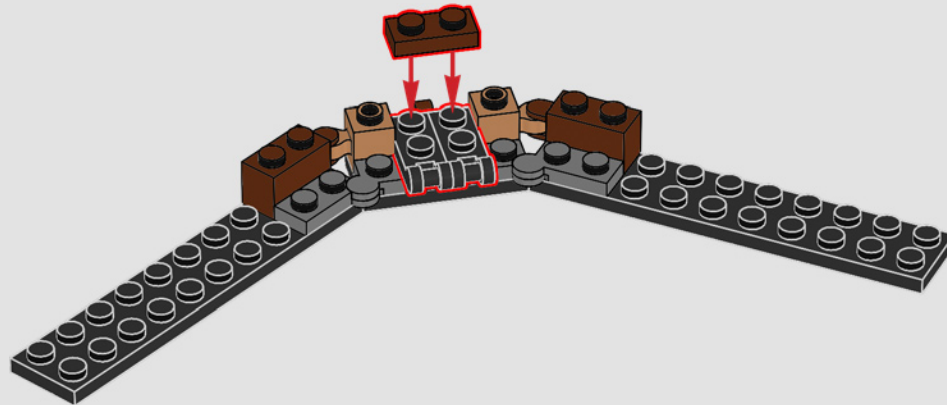

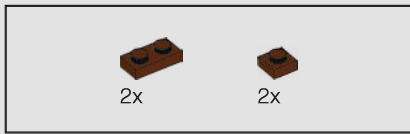

125

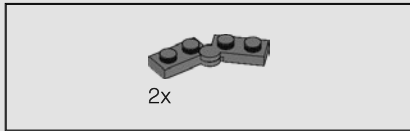

126

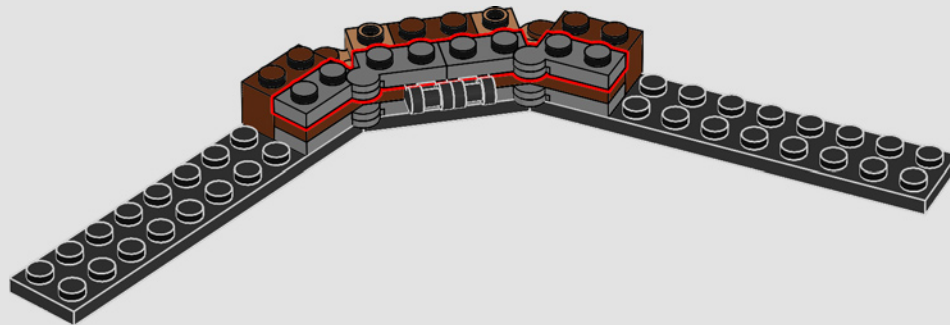

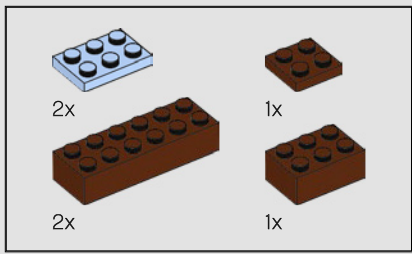

127

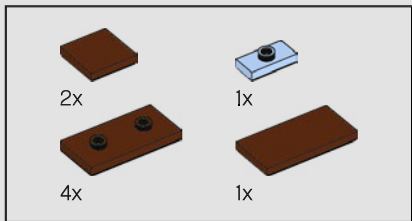
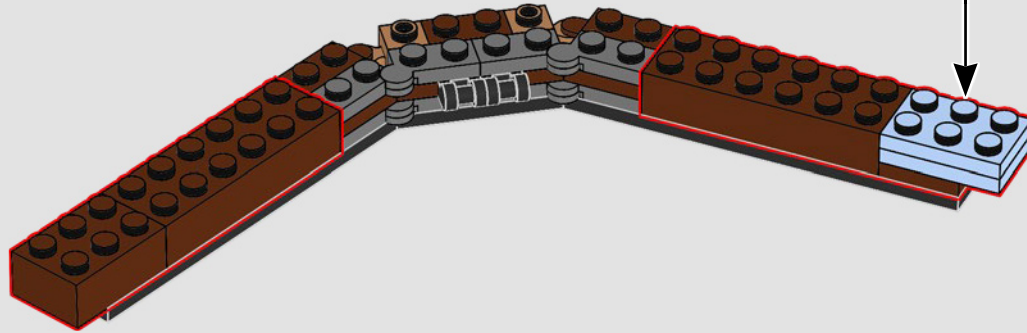
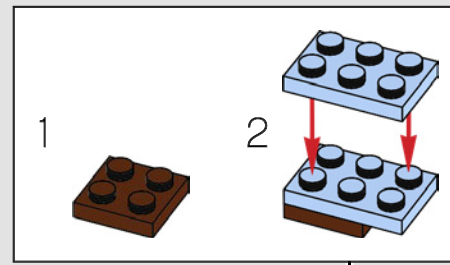

128

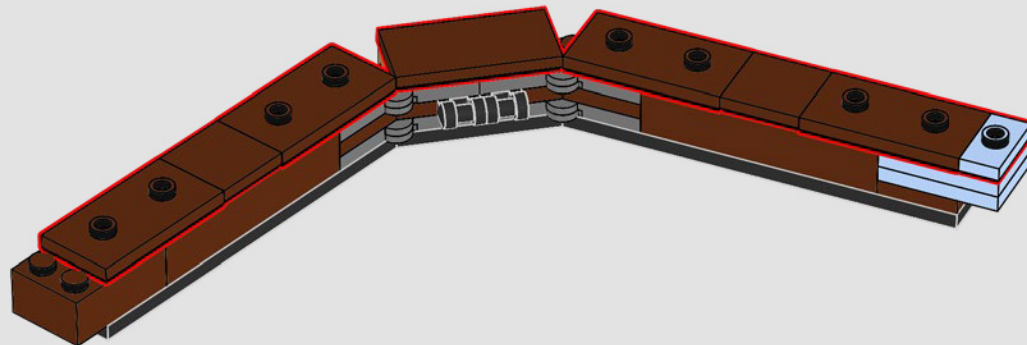

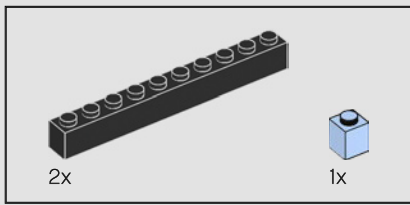

129

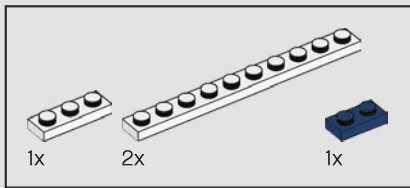
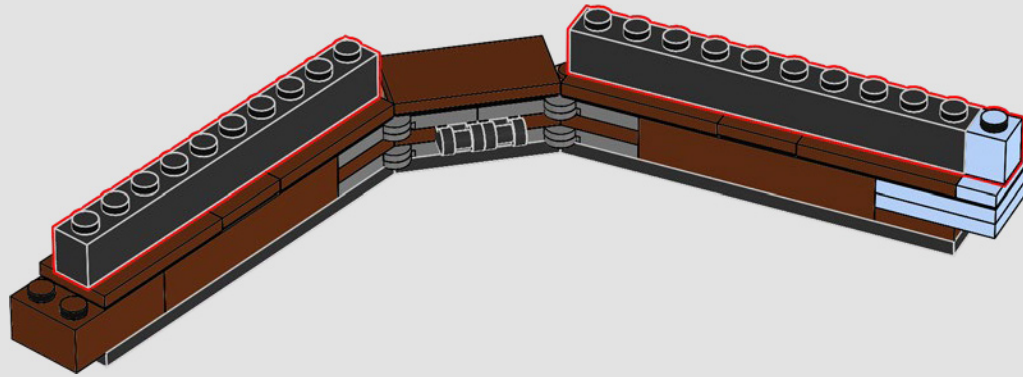

130

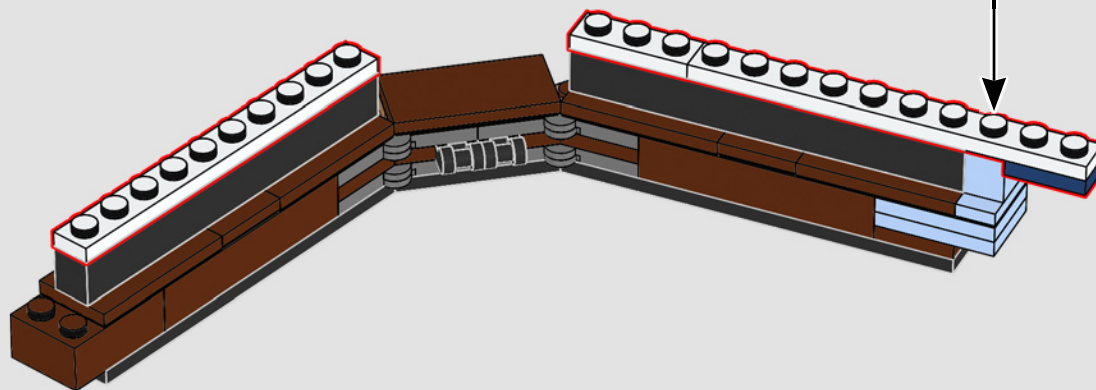
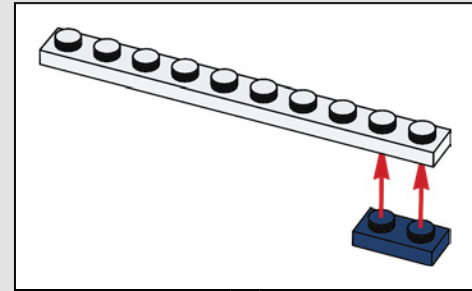

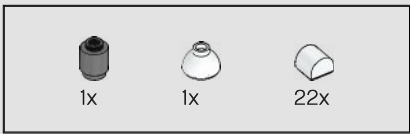

131

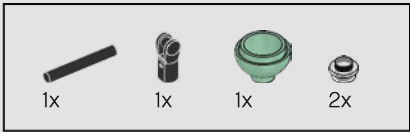
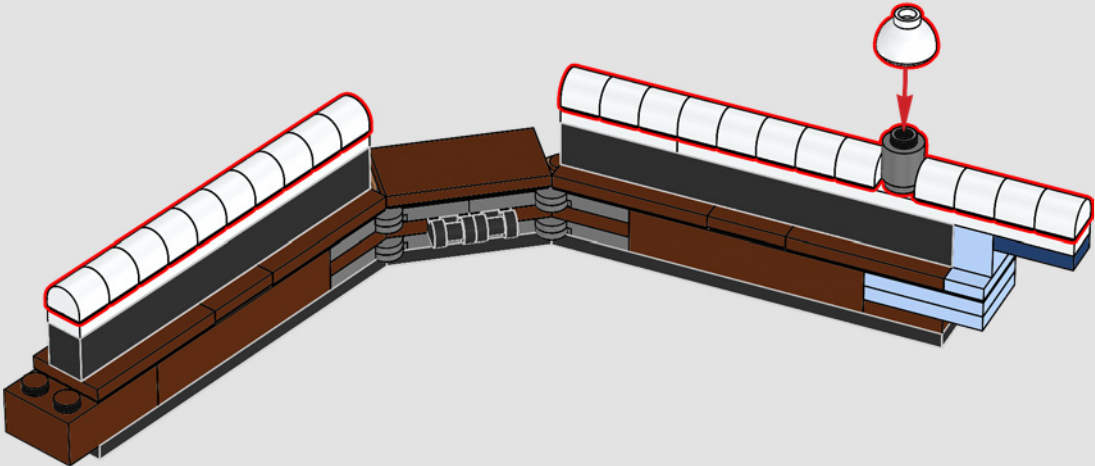

132

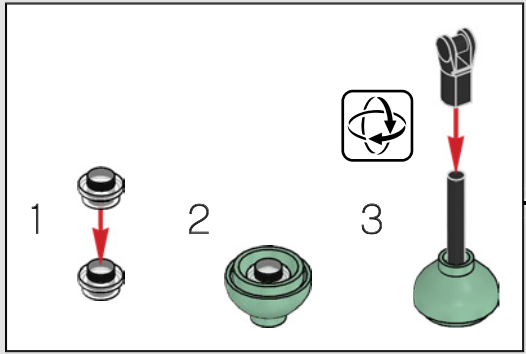
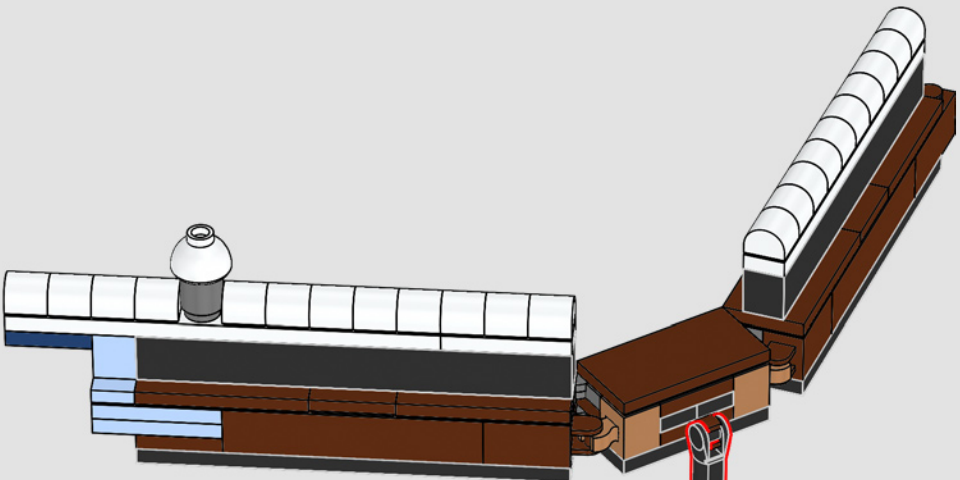



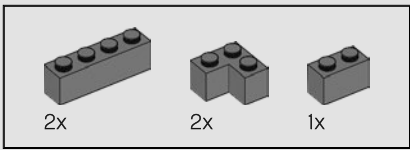

134



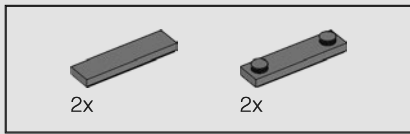

135



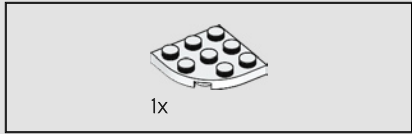

136

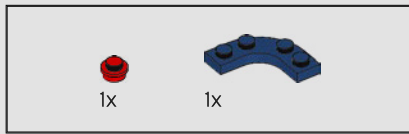

137

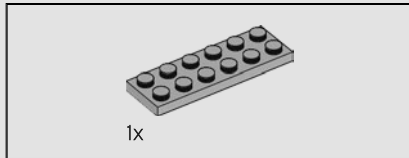

138

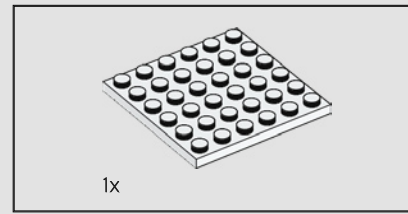
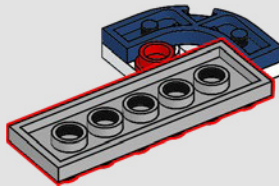

139

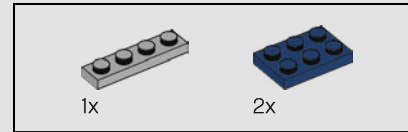
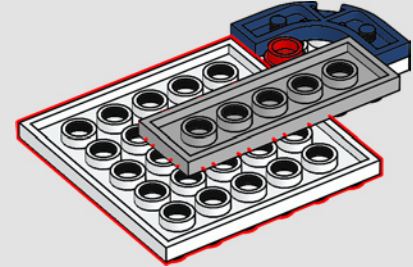

140

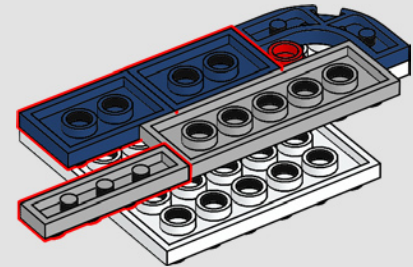

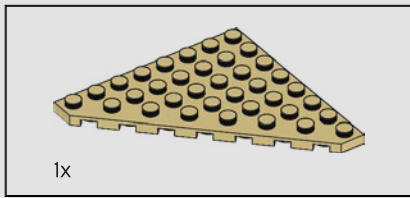

141

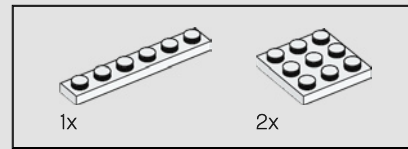
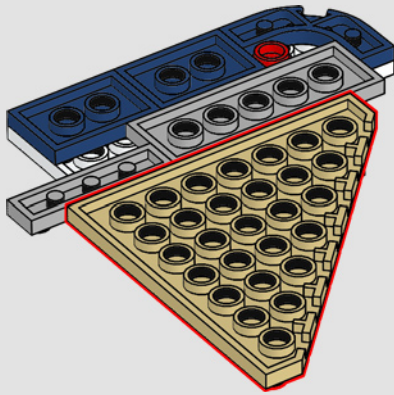

142

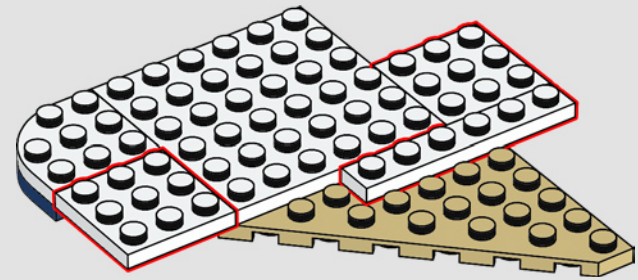
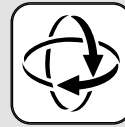

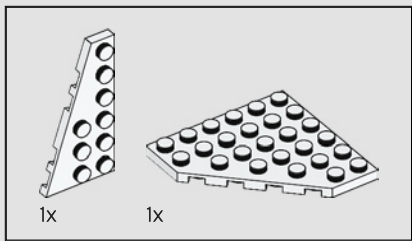

143

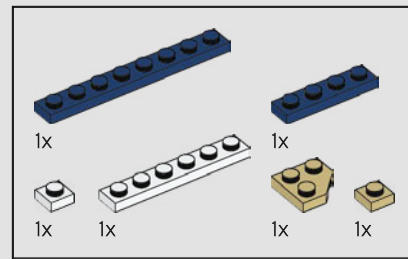
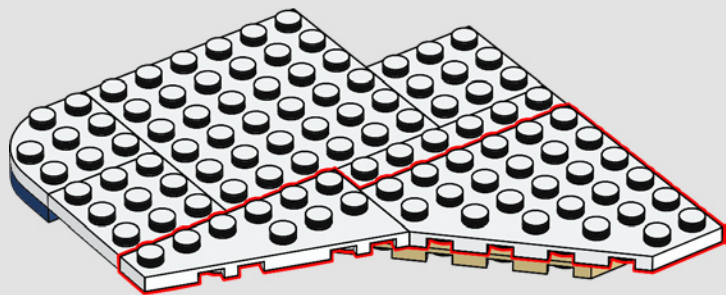

144

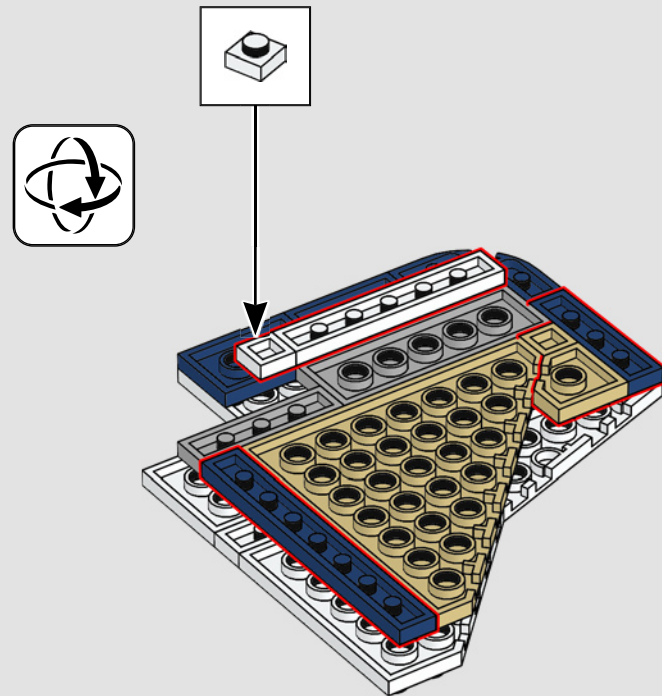

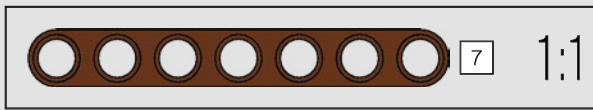
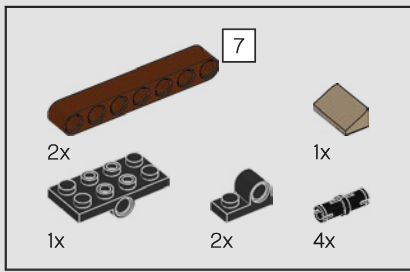

145

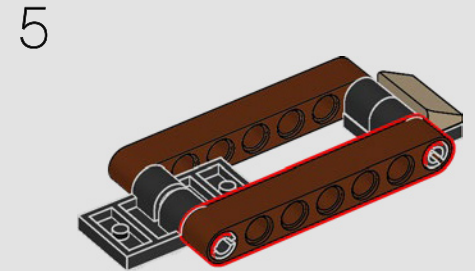
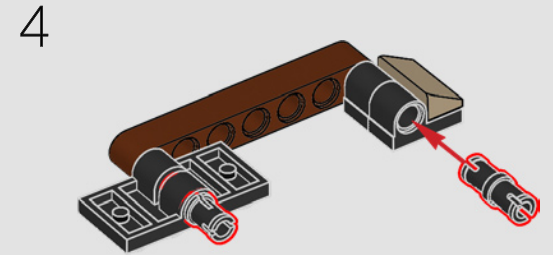
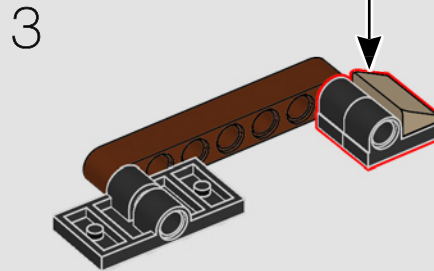
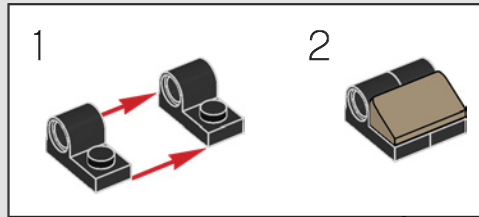
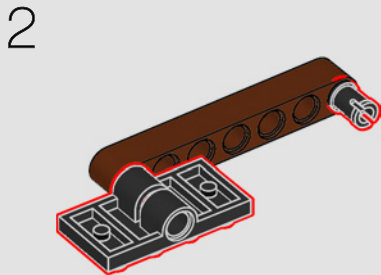
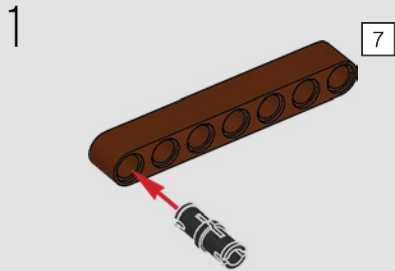

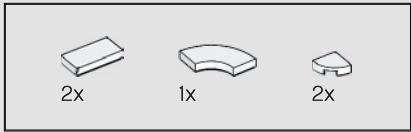
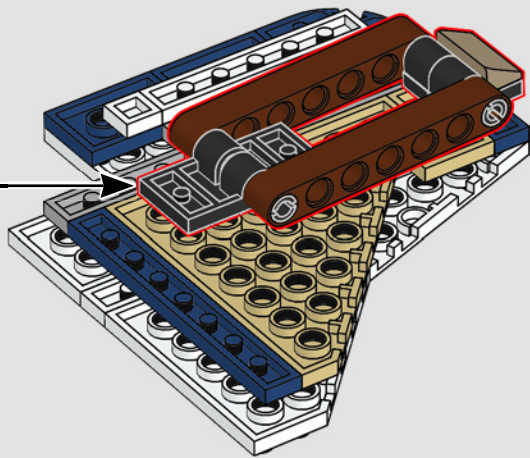

146

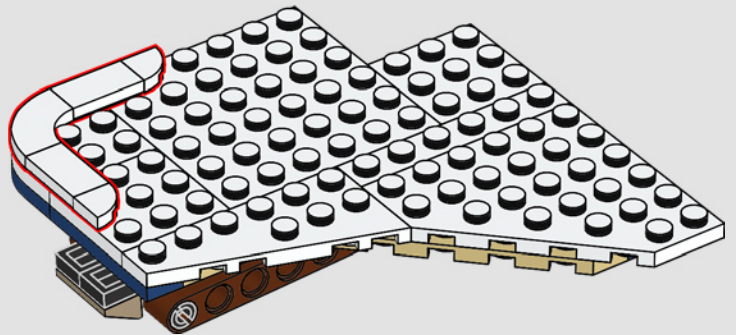

147

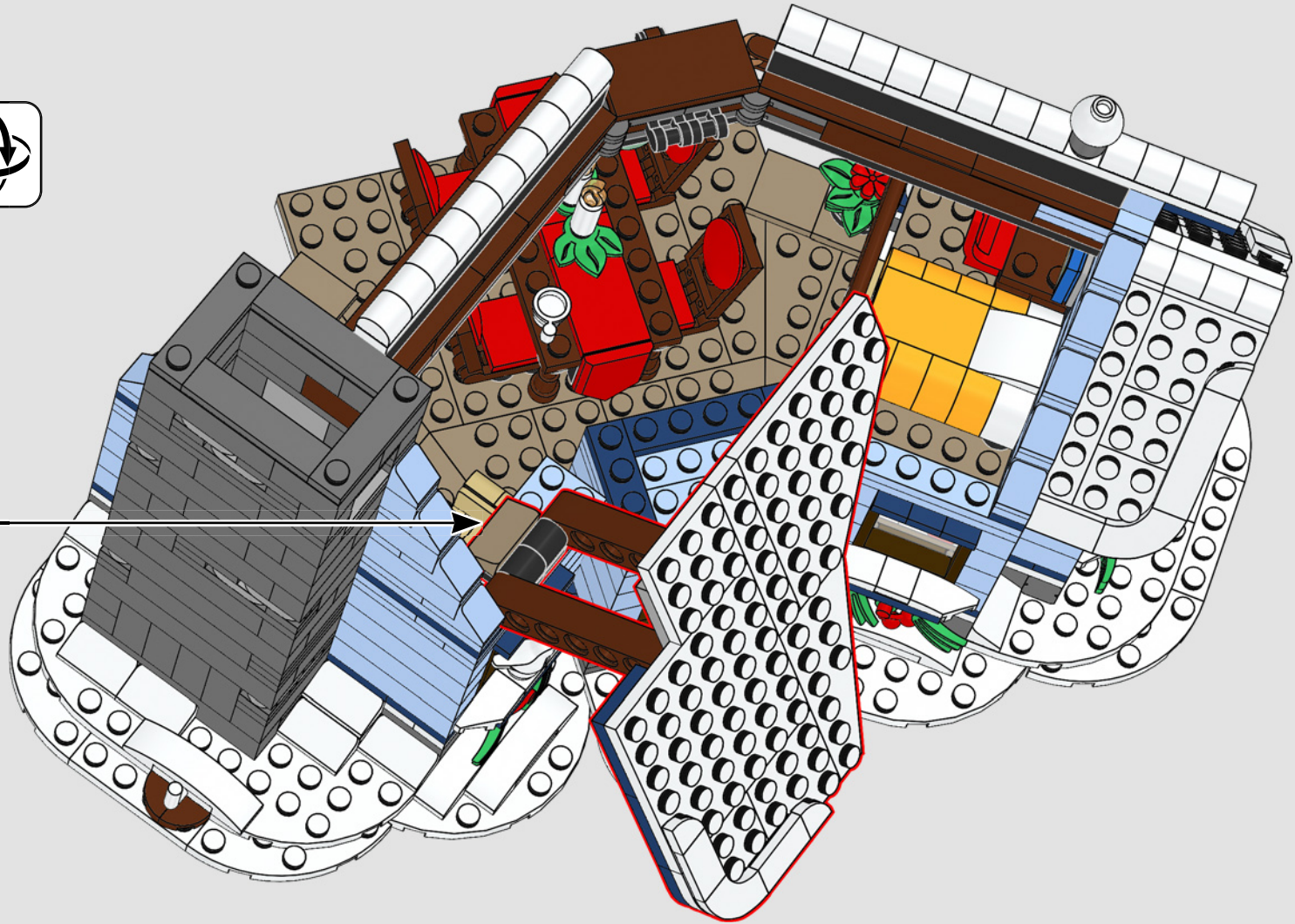



148

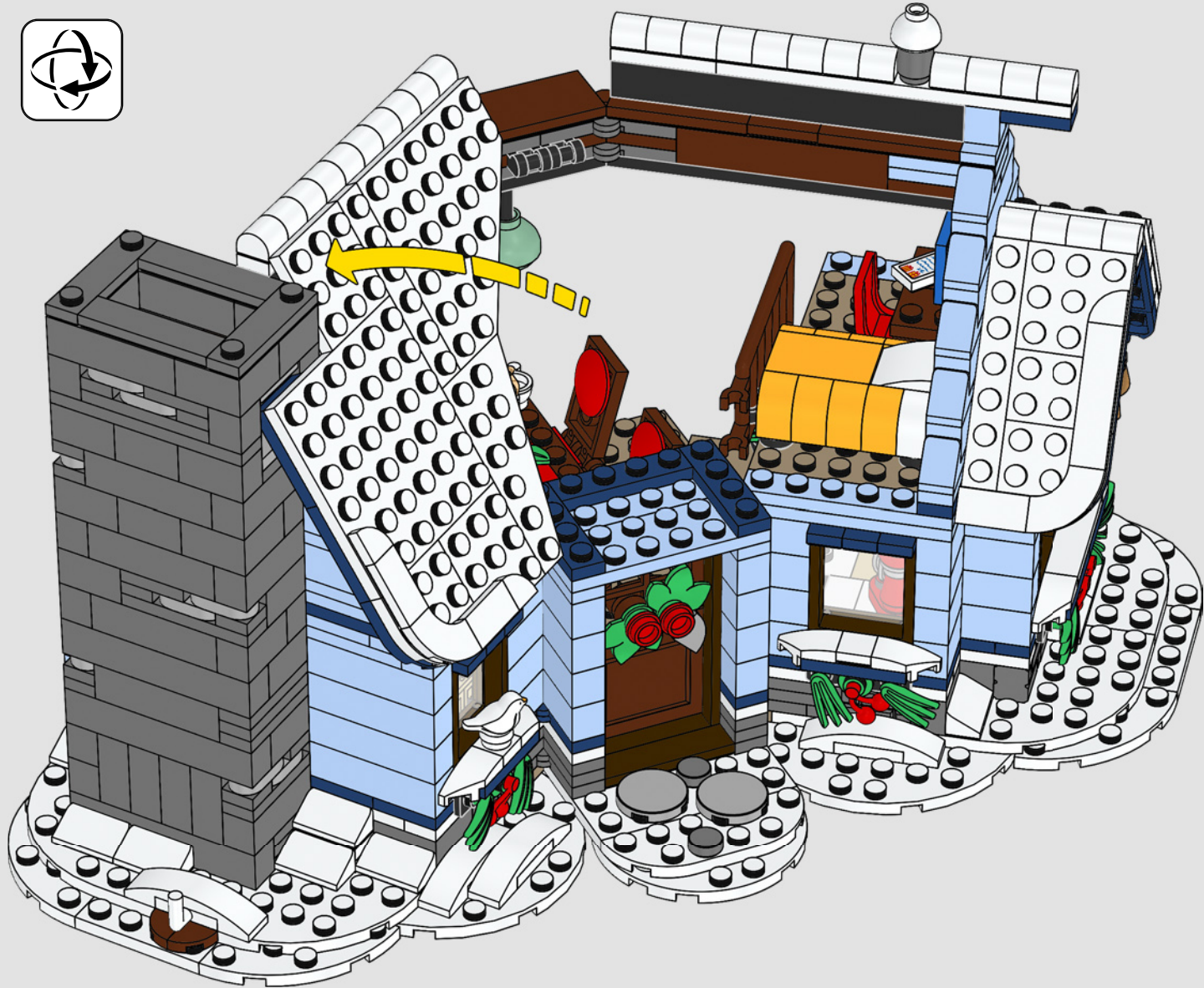

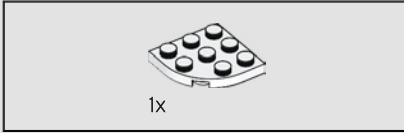
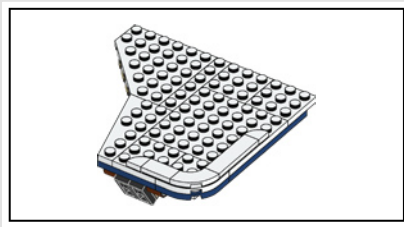

149

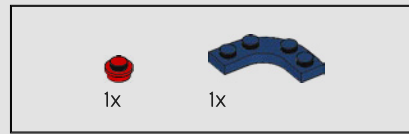

150

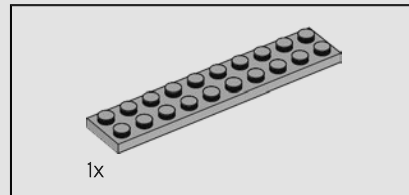

151

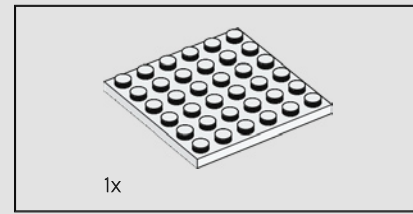
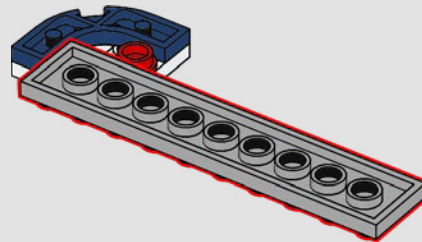

152

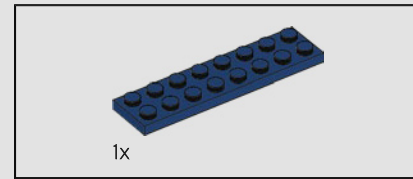
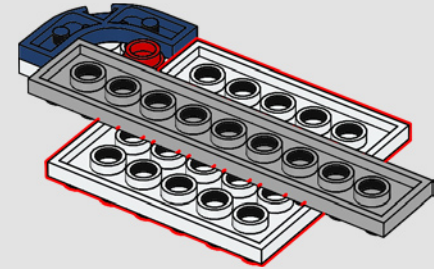

153

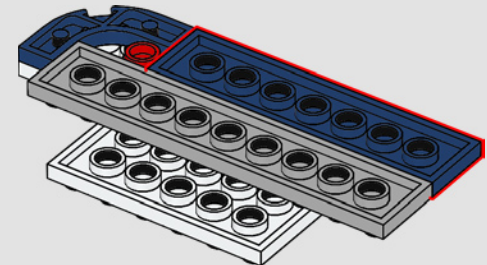

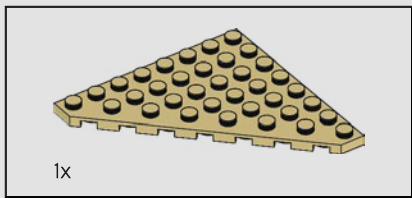

154

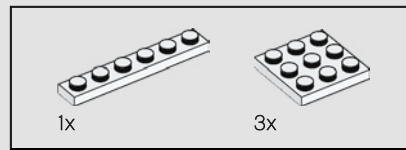
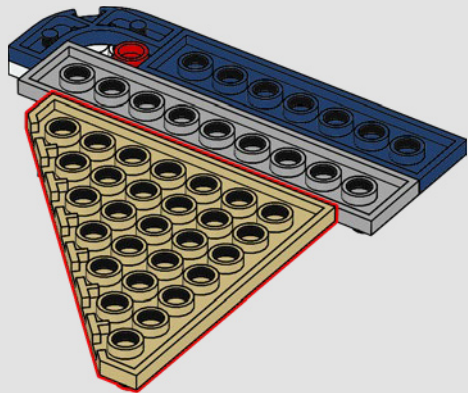

155

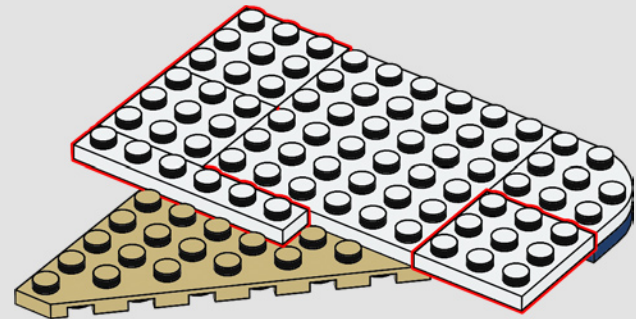
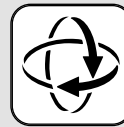

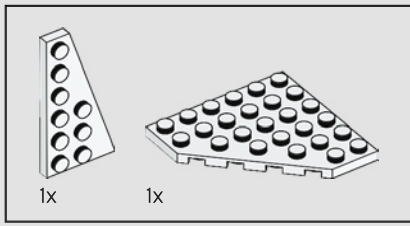

156

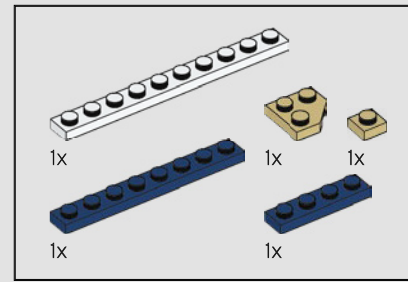
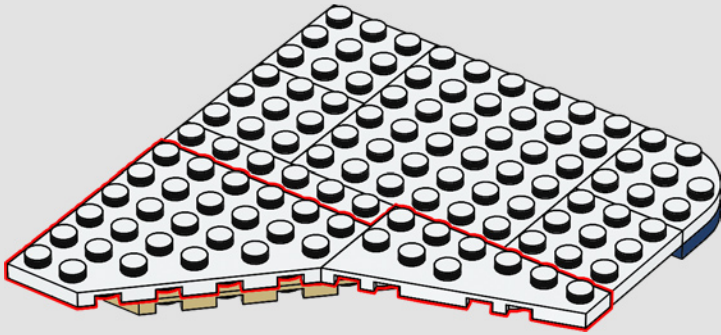

157

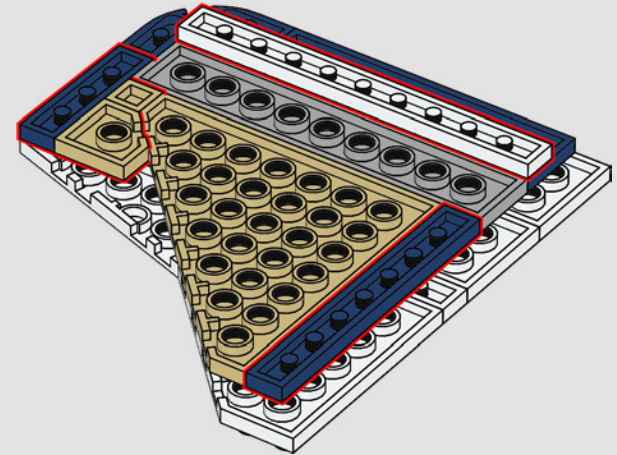
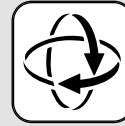

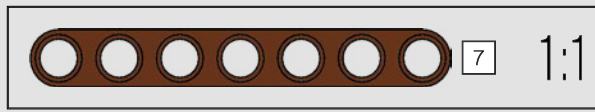
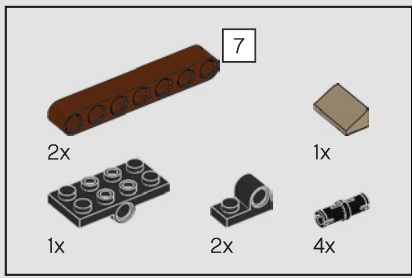

158

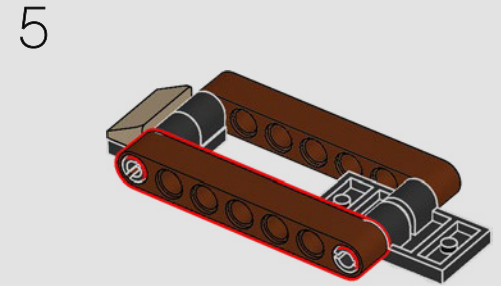
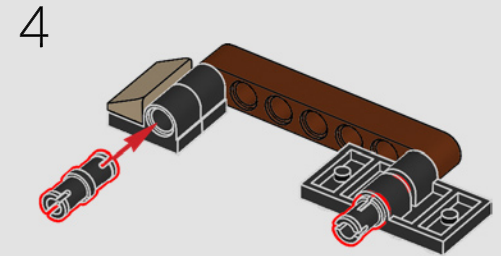
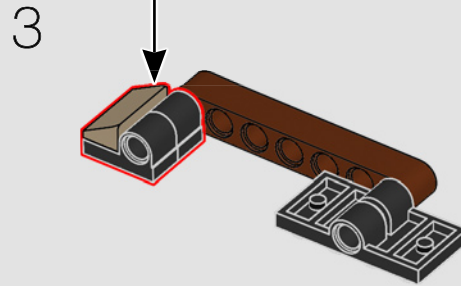
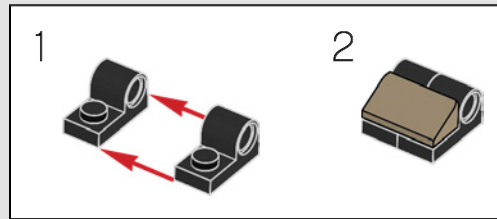
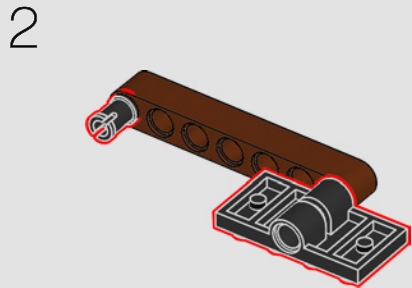
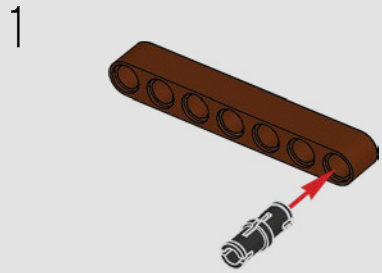

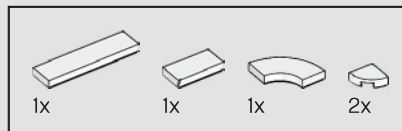
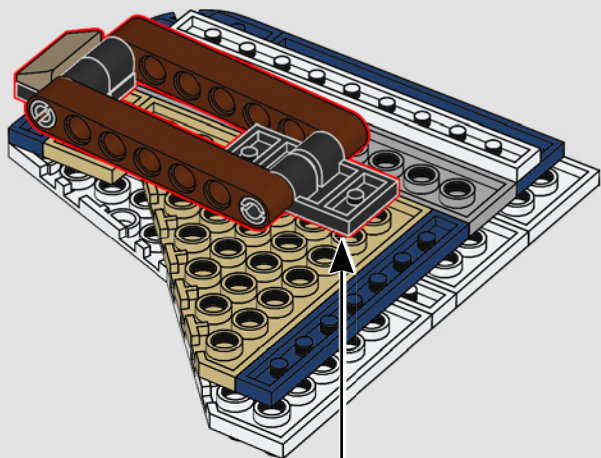

159

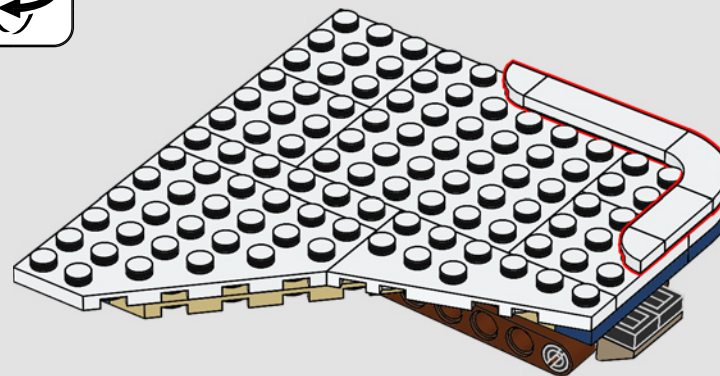

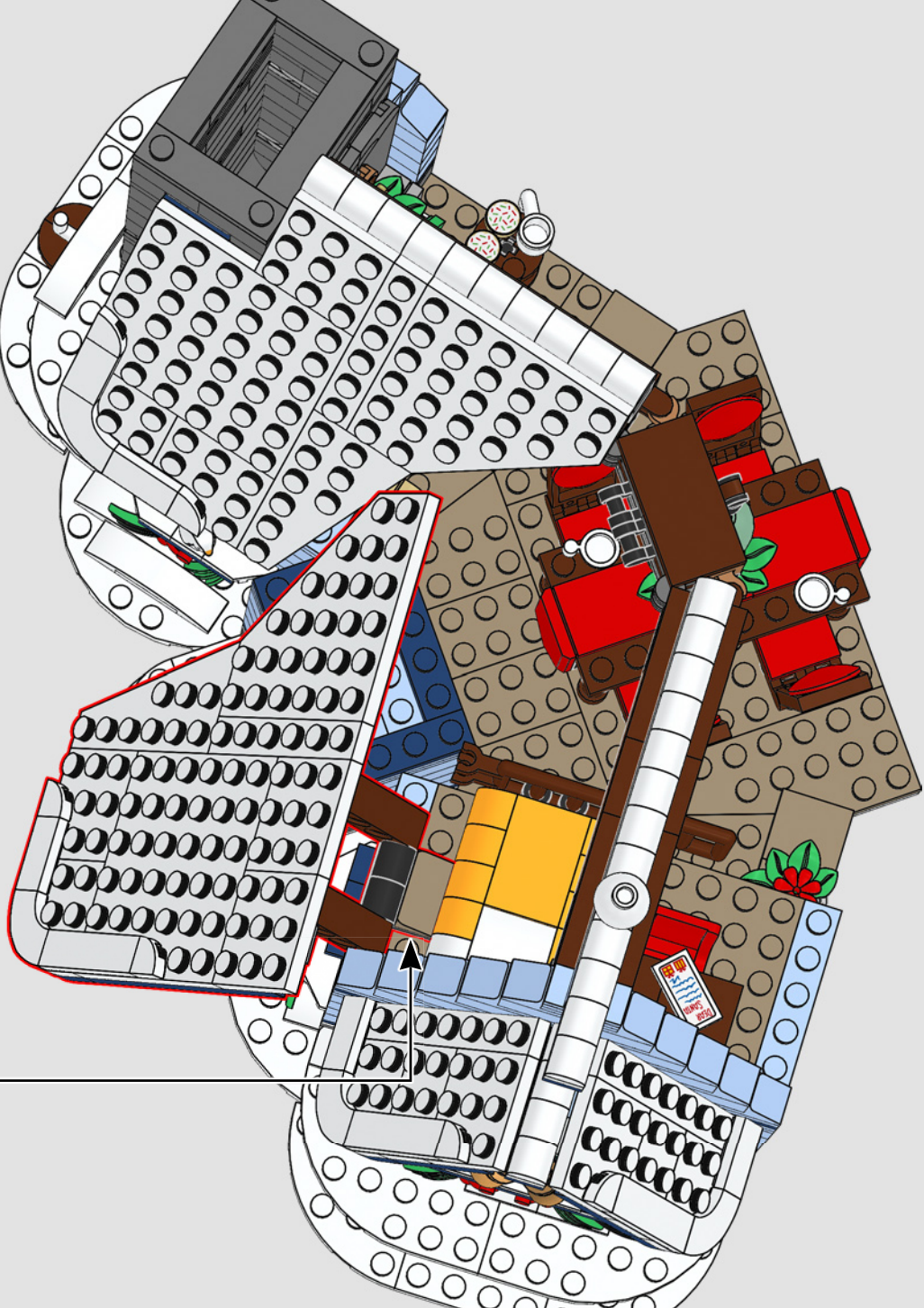

161

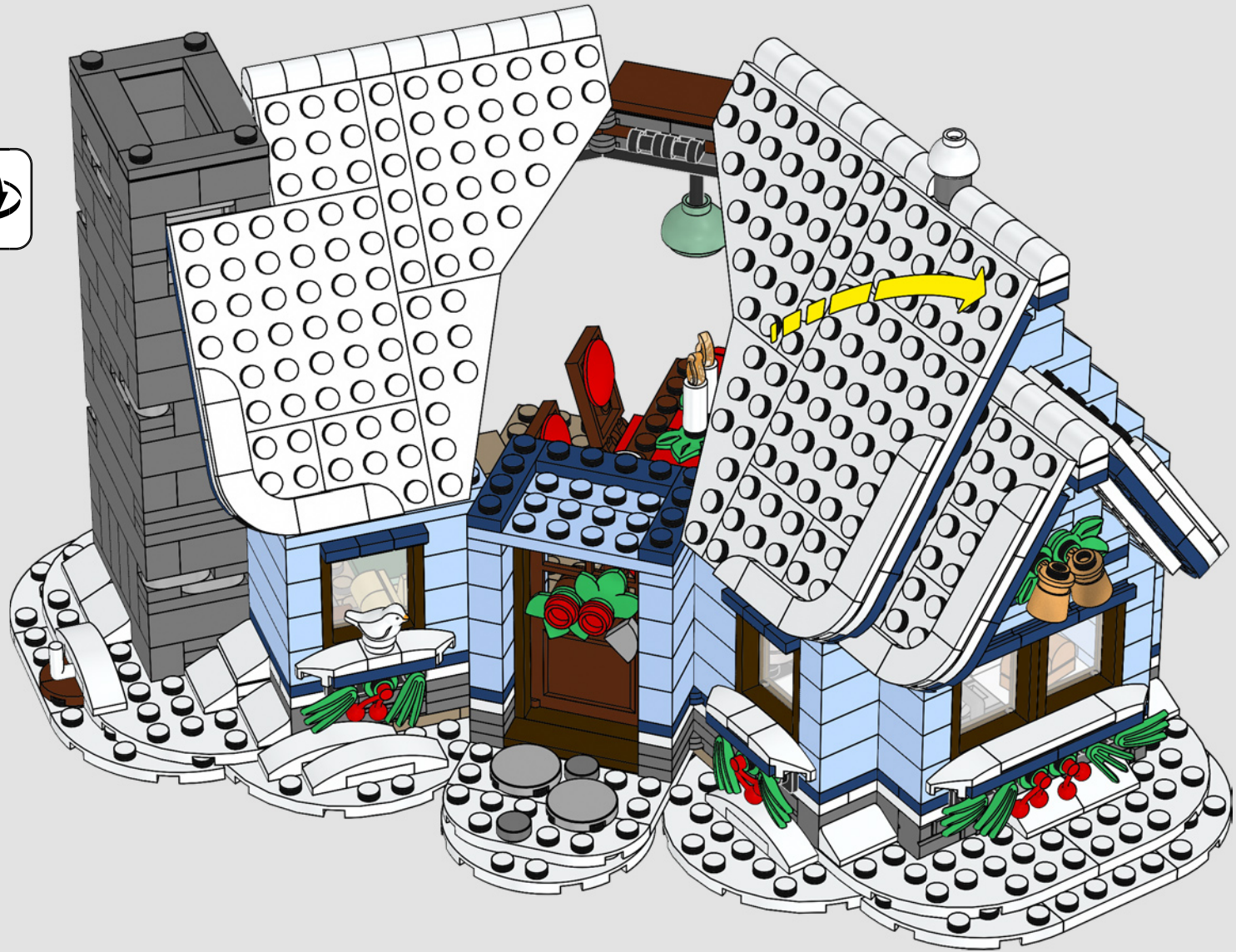

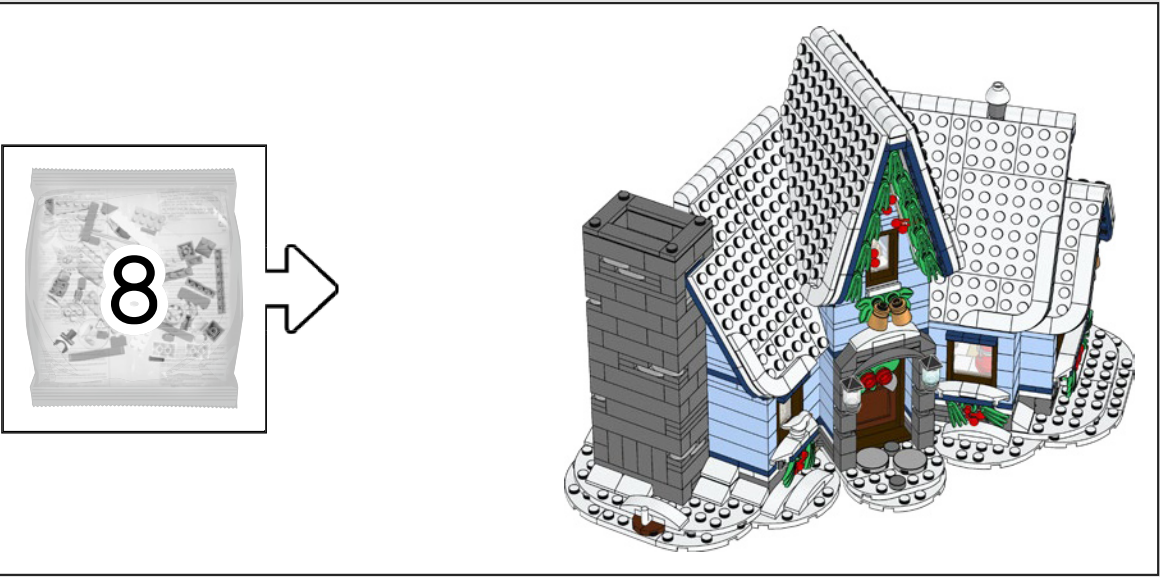



162

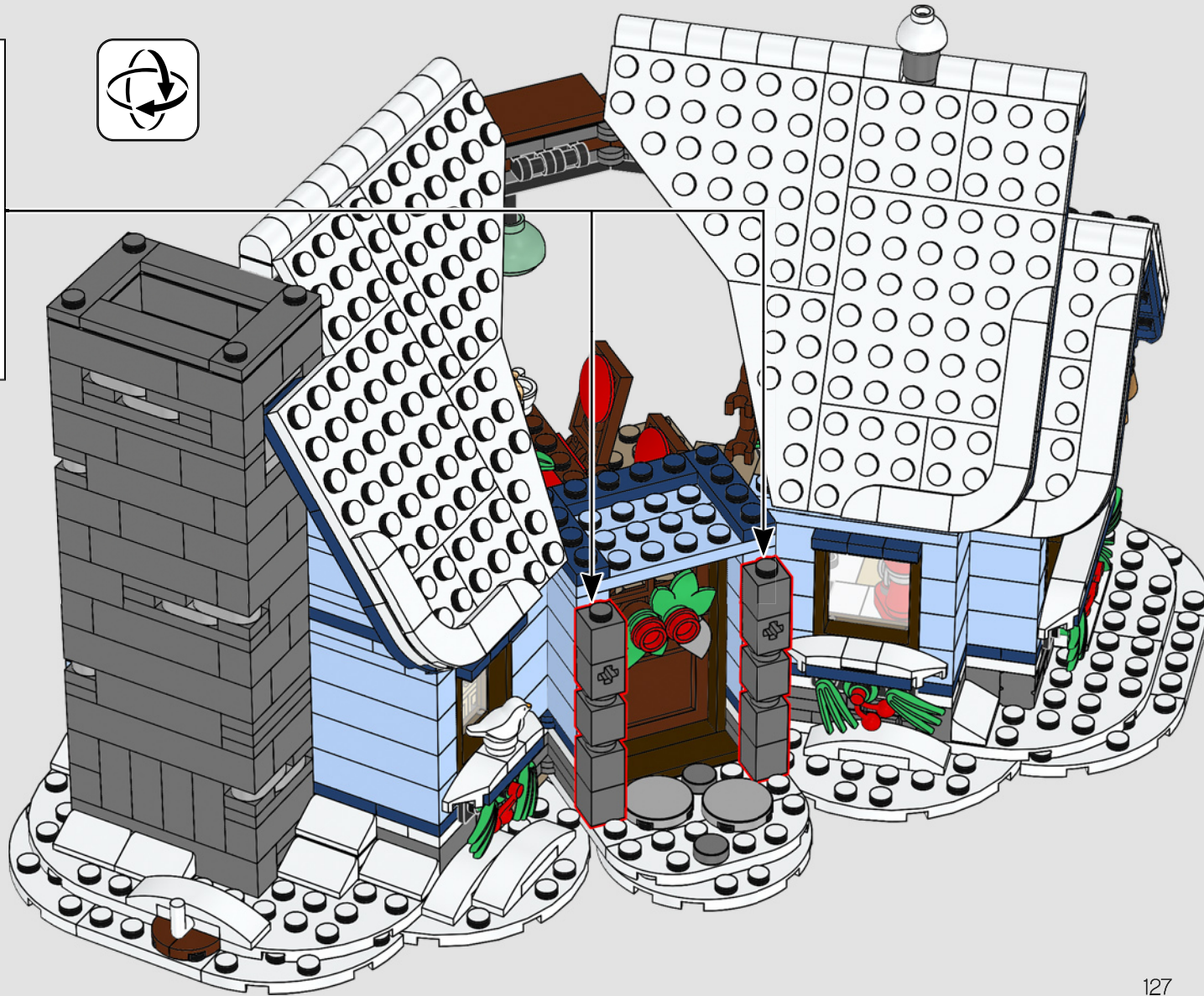
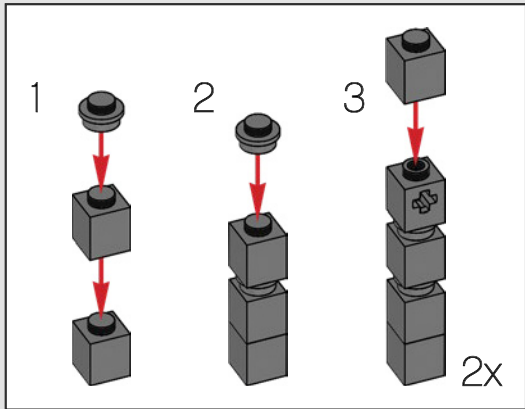

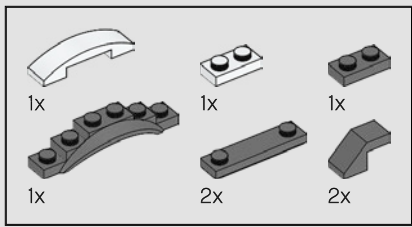

163

1

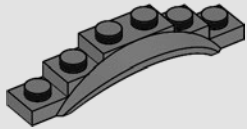

2

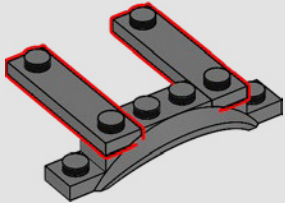

3

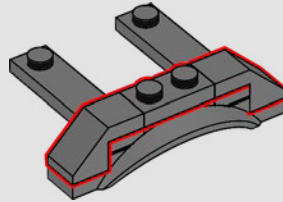

4

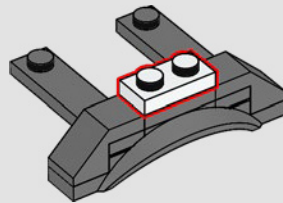

5

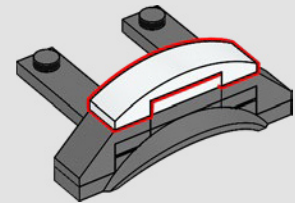

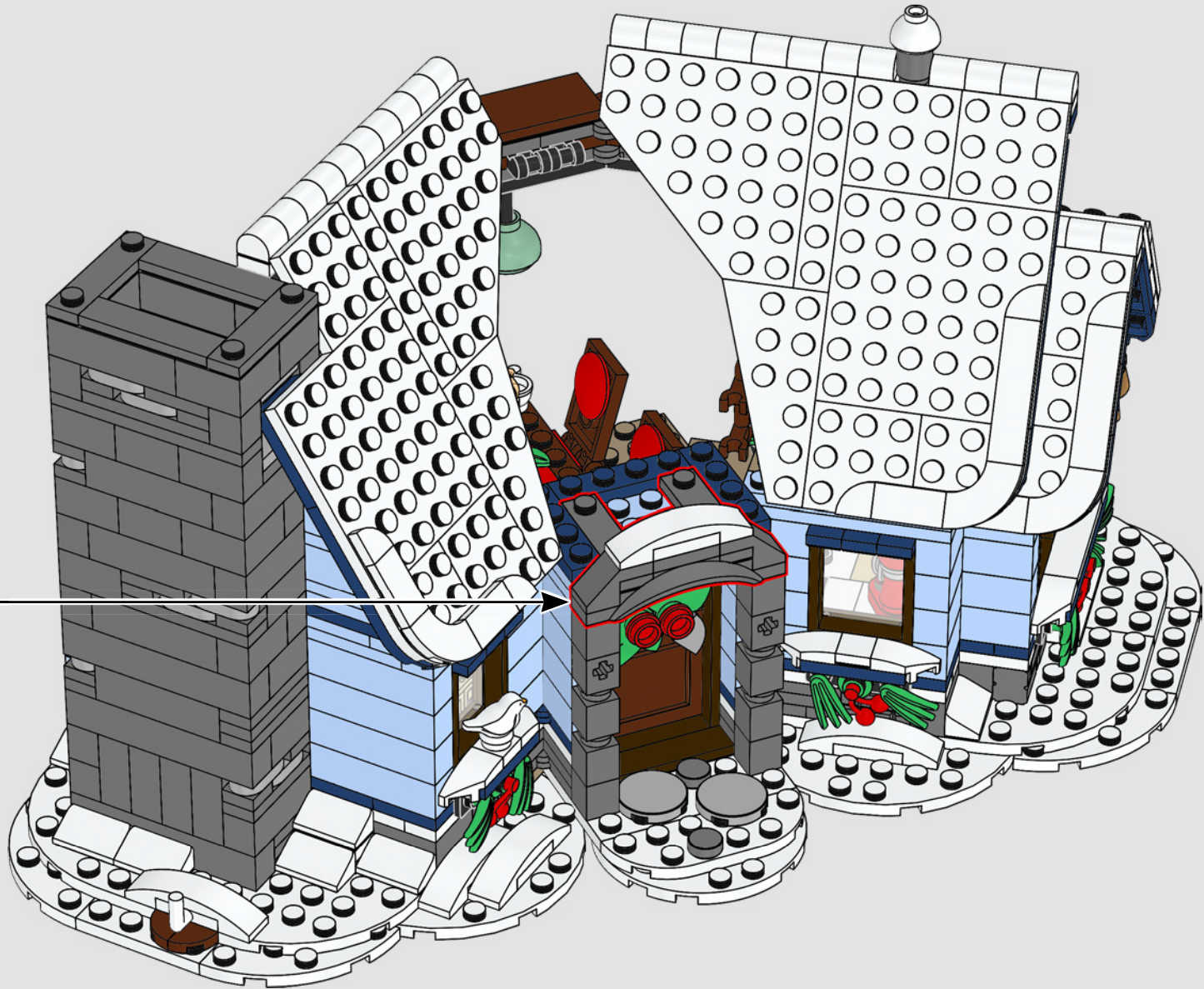

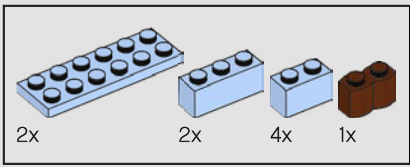

164

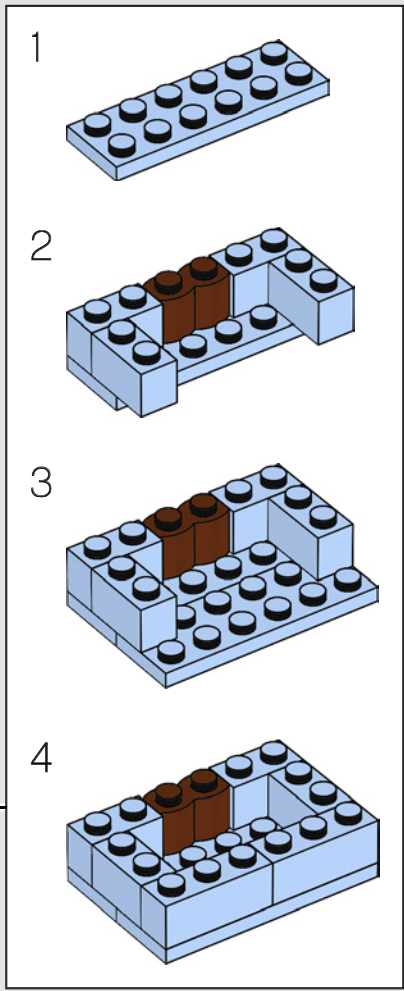
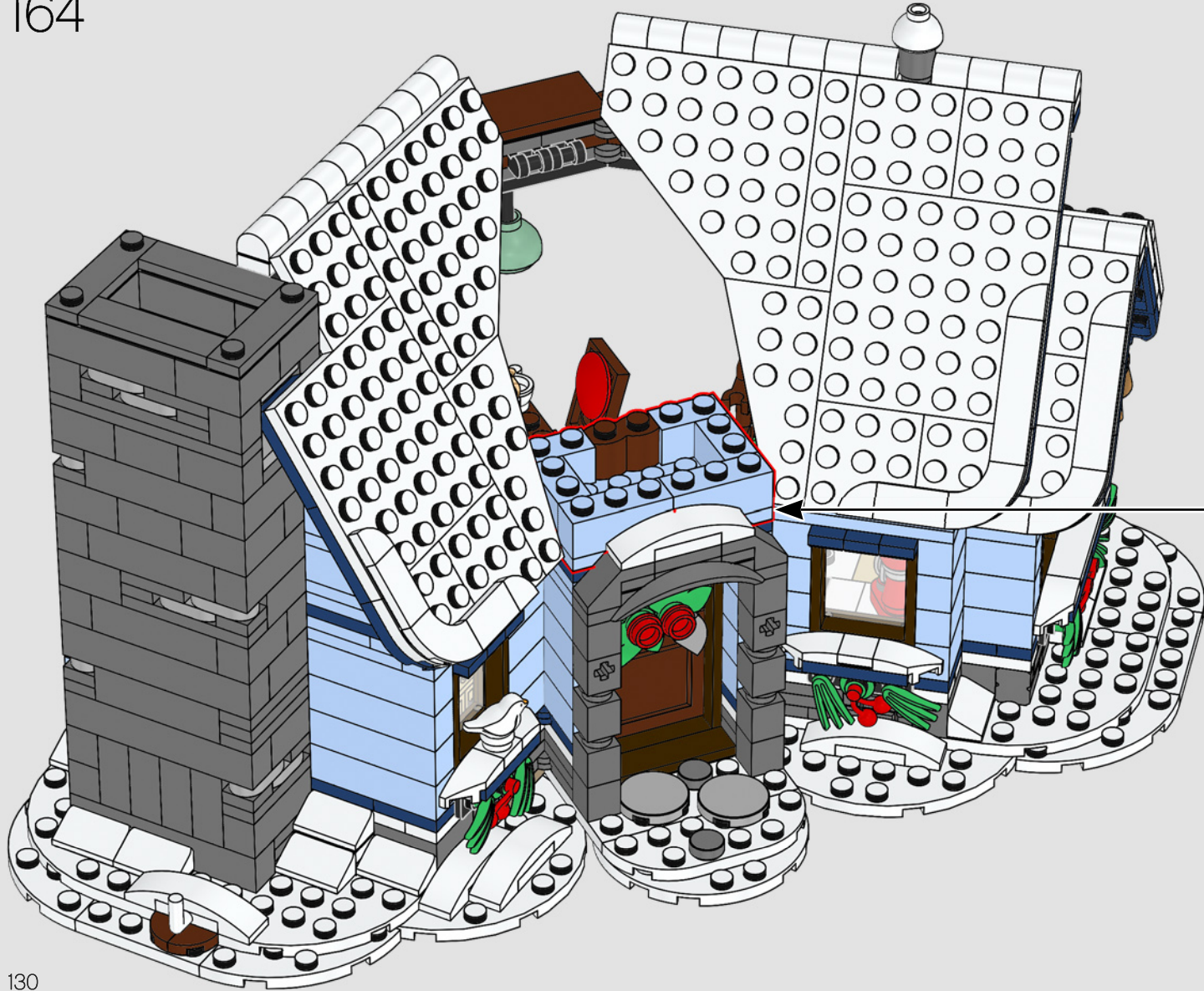

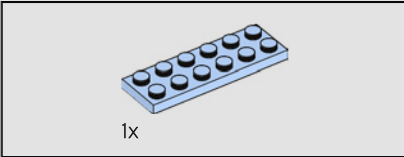
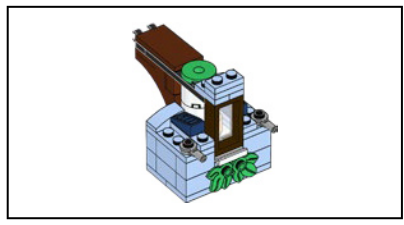

1x

165

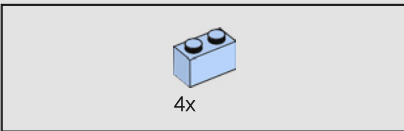
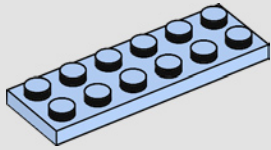

4x

166

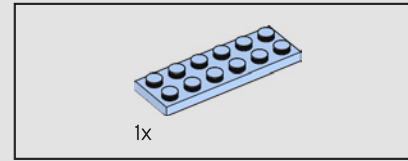
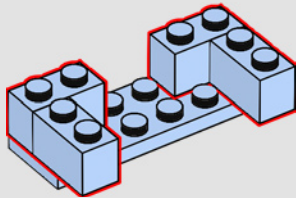

1x

167

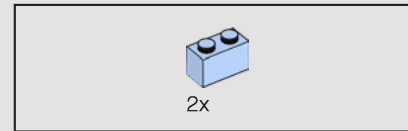
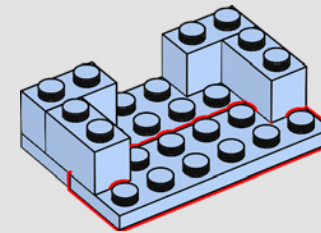

2x

168

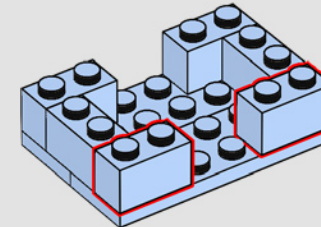

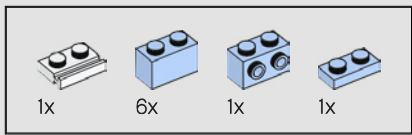

169

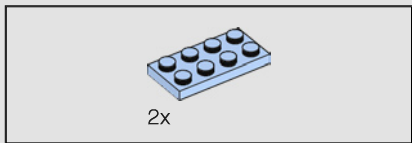
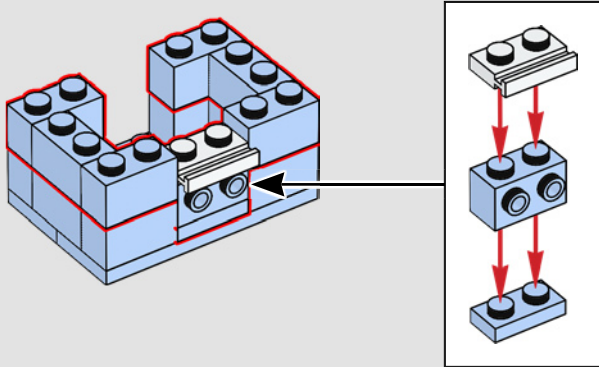

170

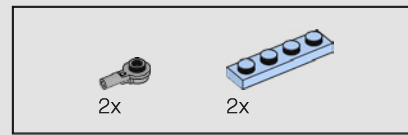
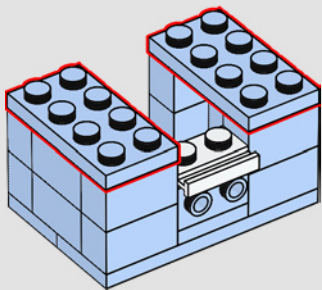

171

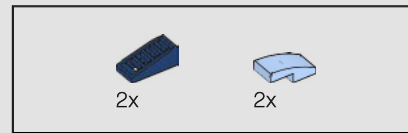
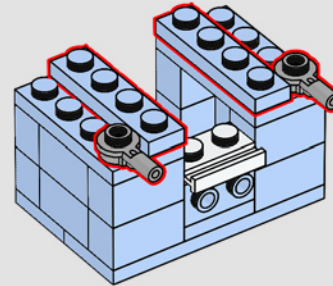

172

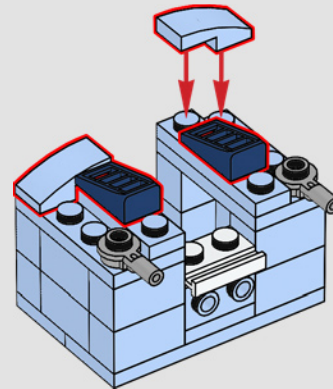

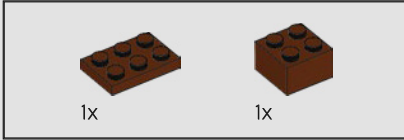
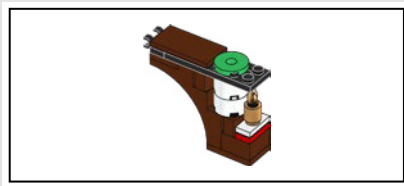

173

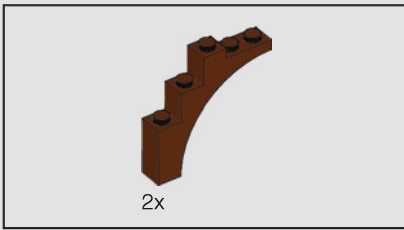
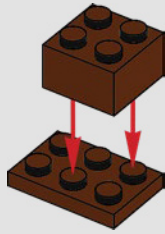

174

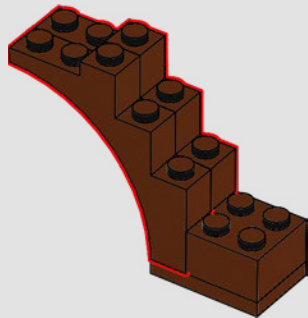

175

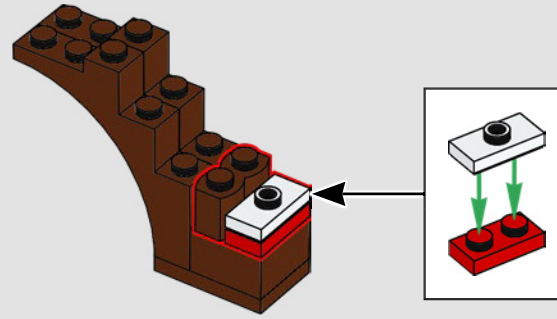

176

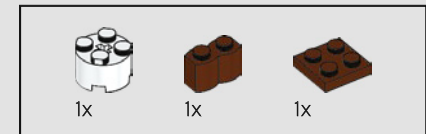
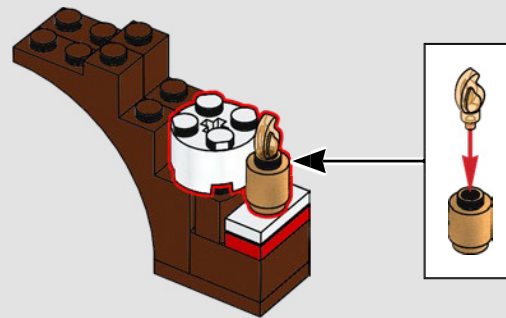

177

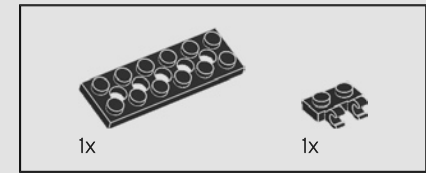
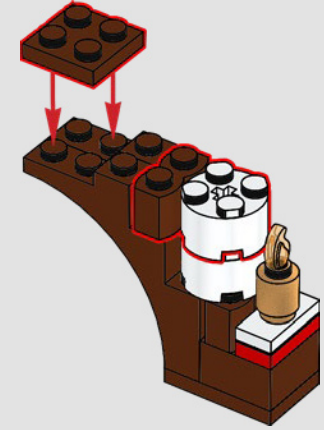

178

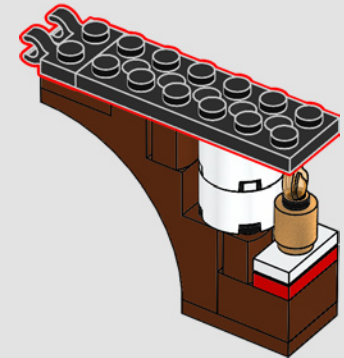



179

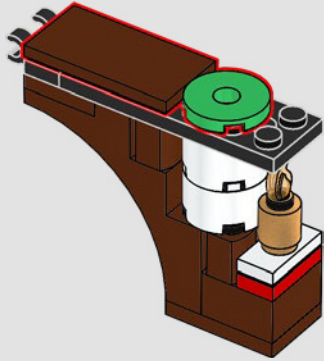

180

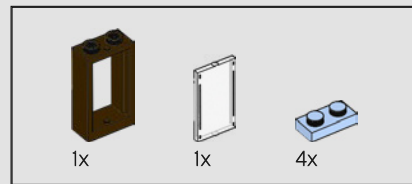
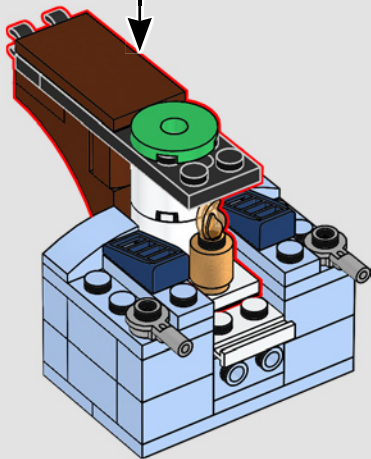

181

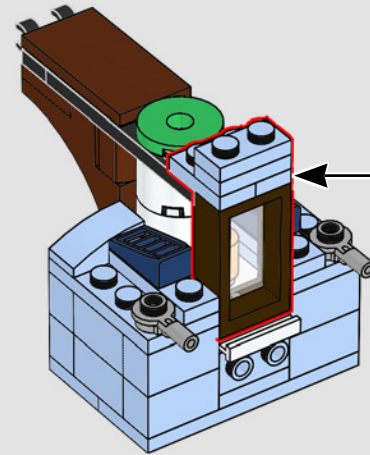
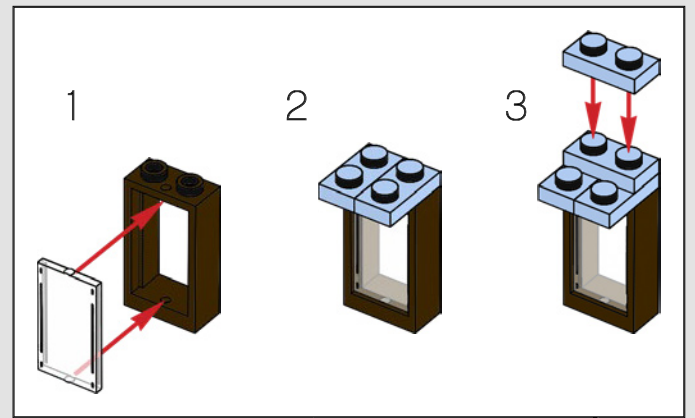



2x

182

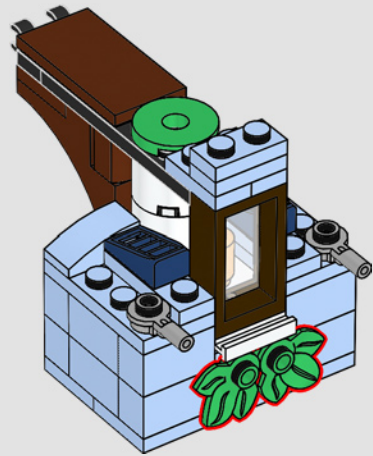

183

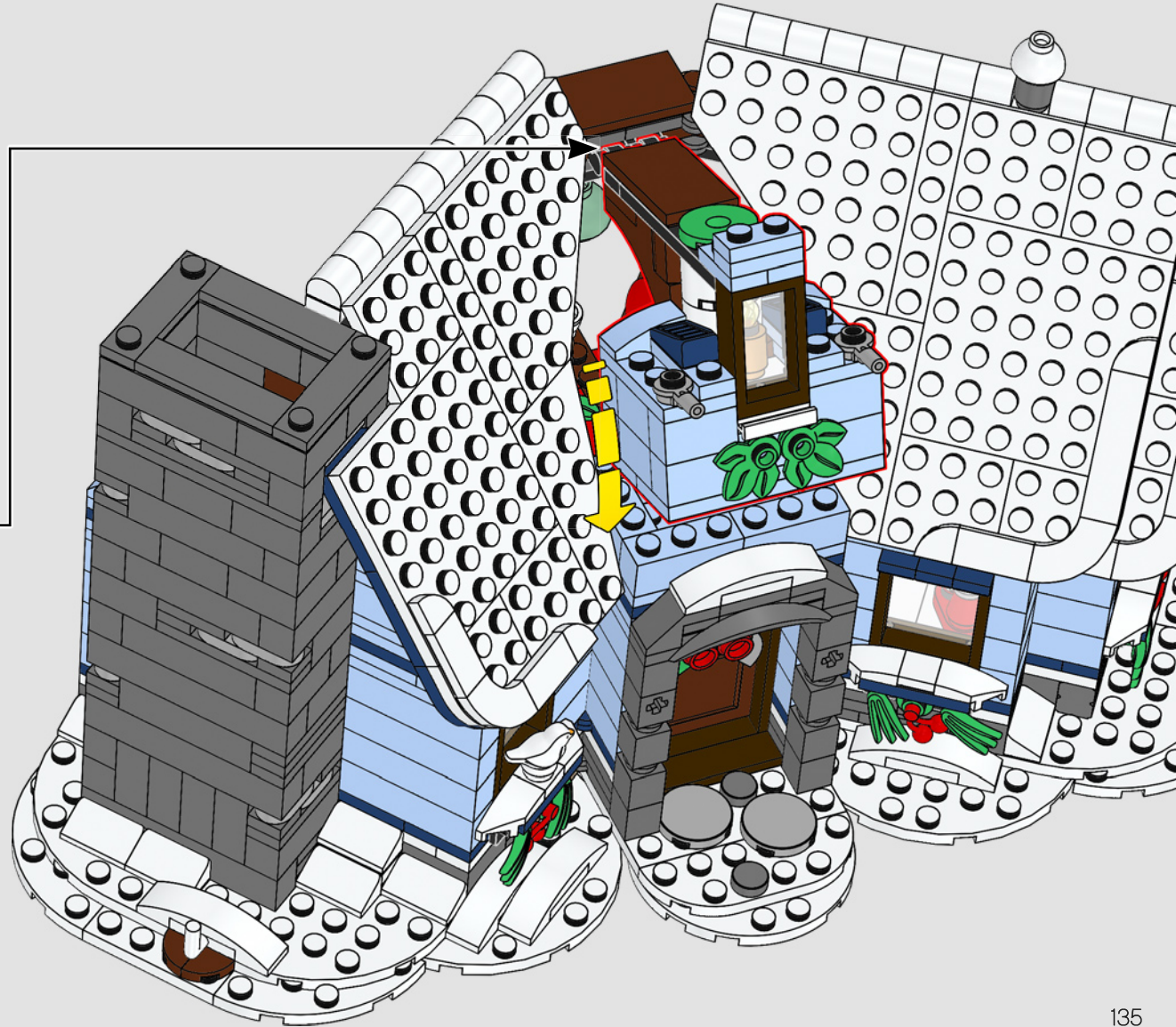



184

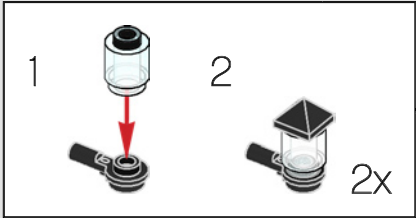
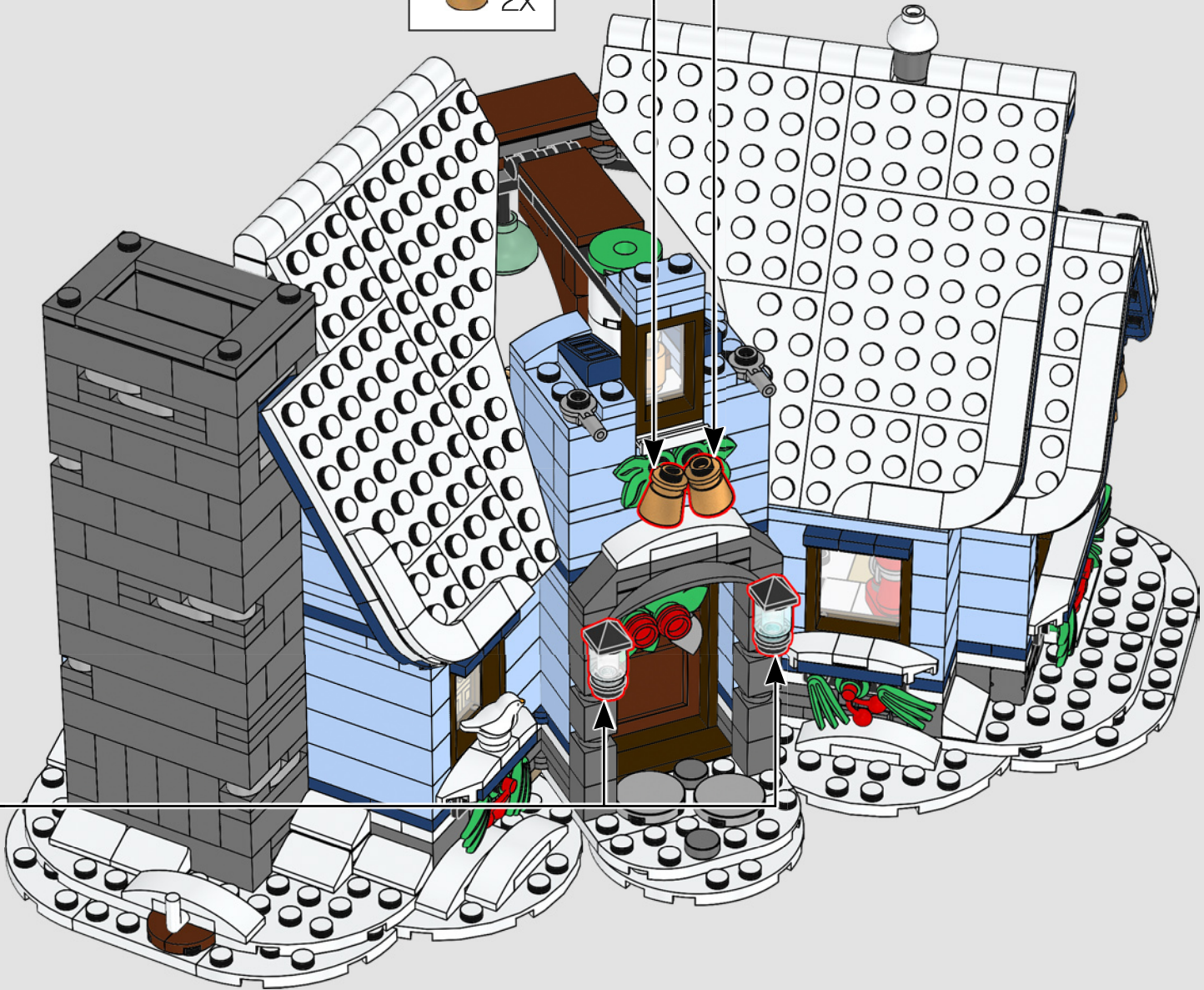
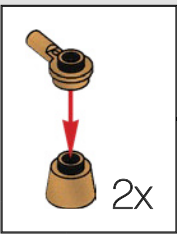

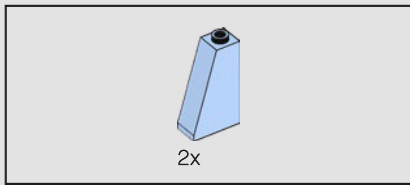

185

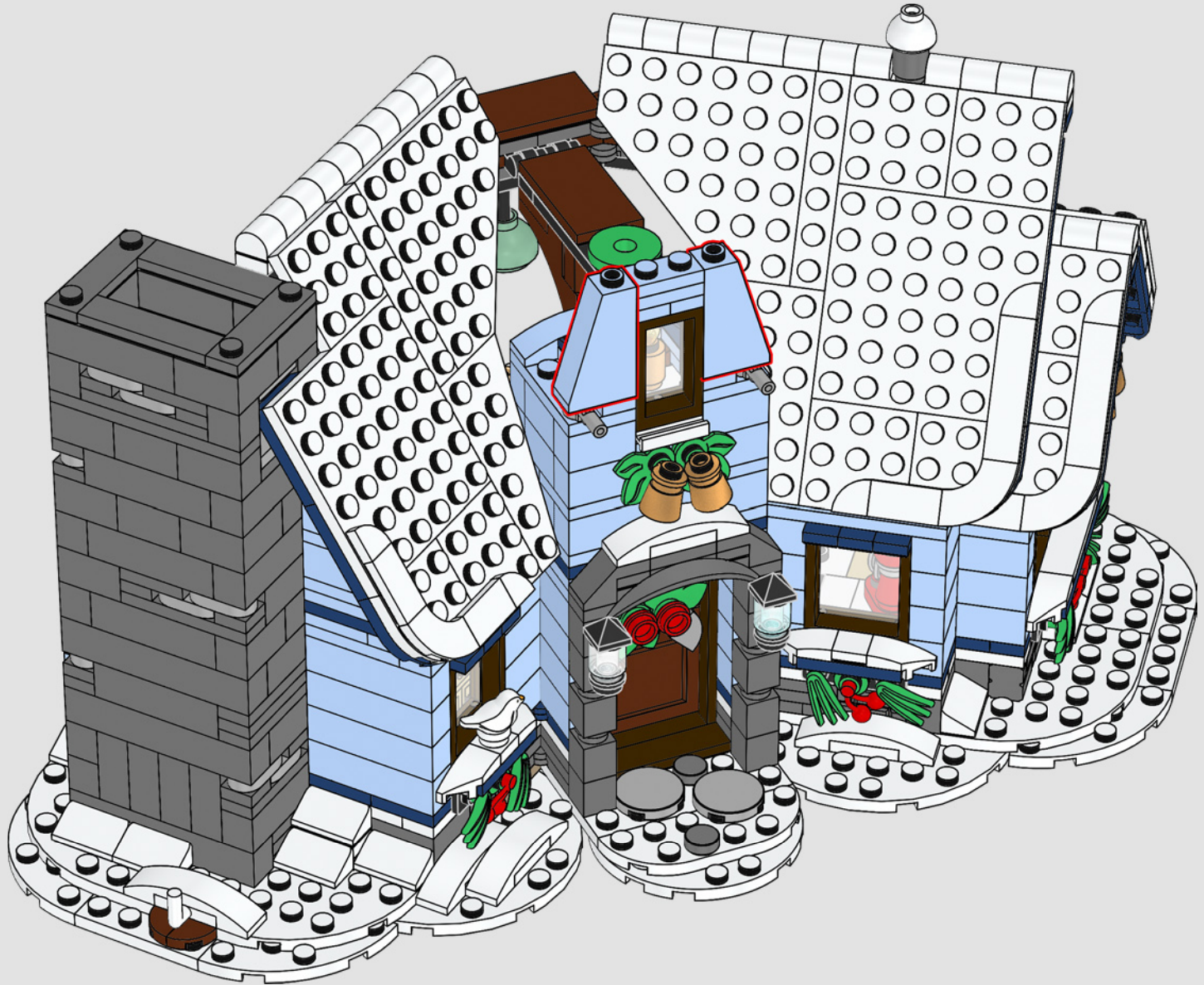

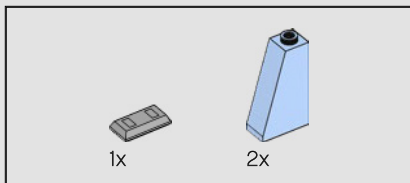

186

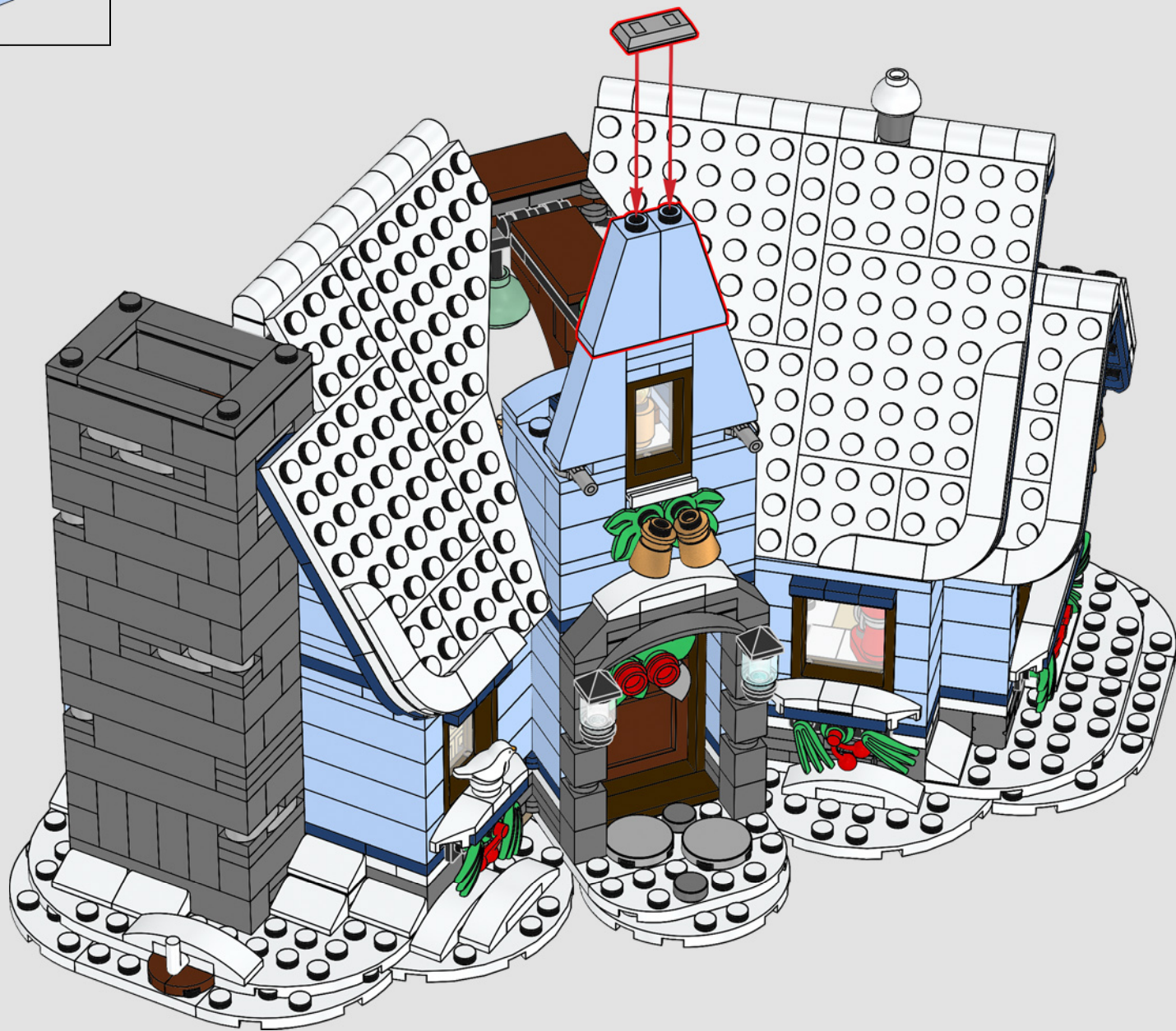

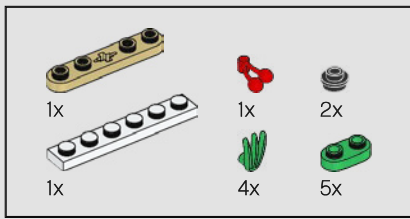

187

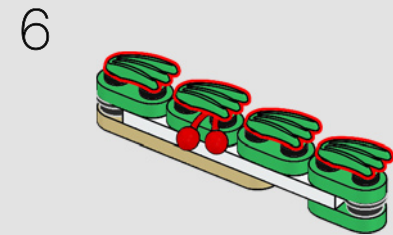
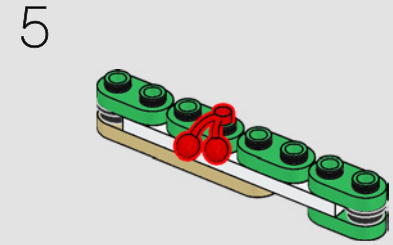
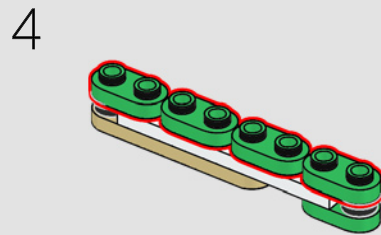
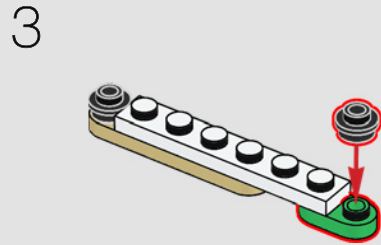
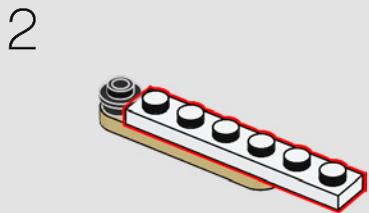
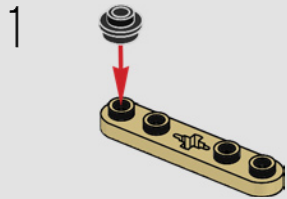

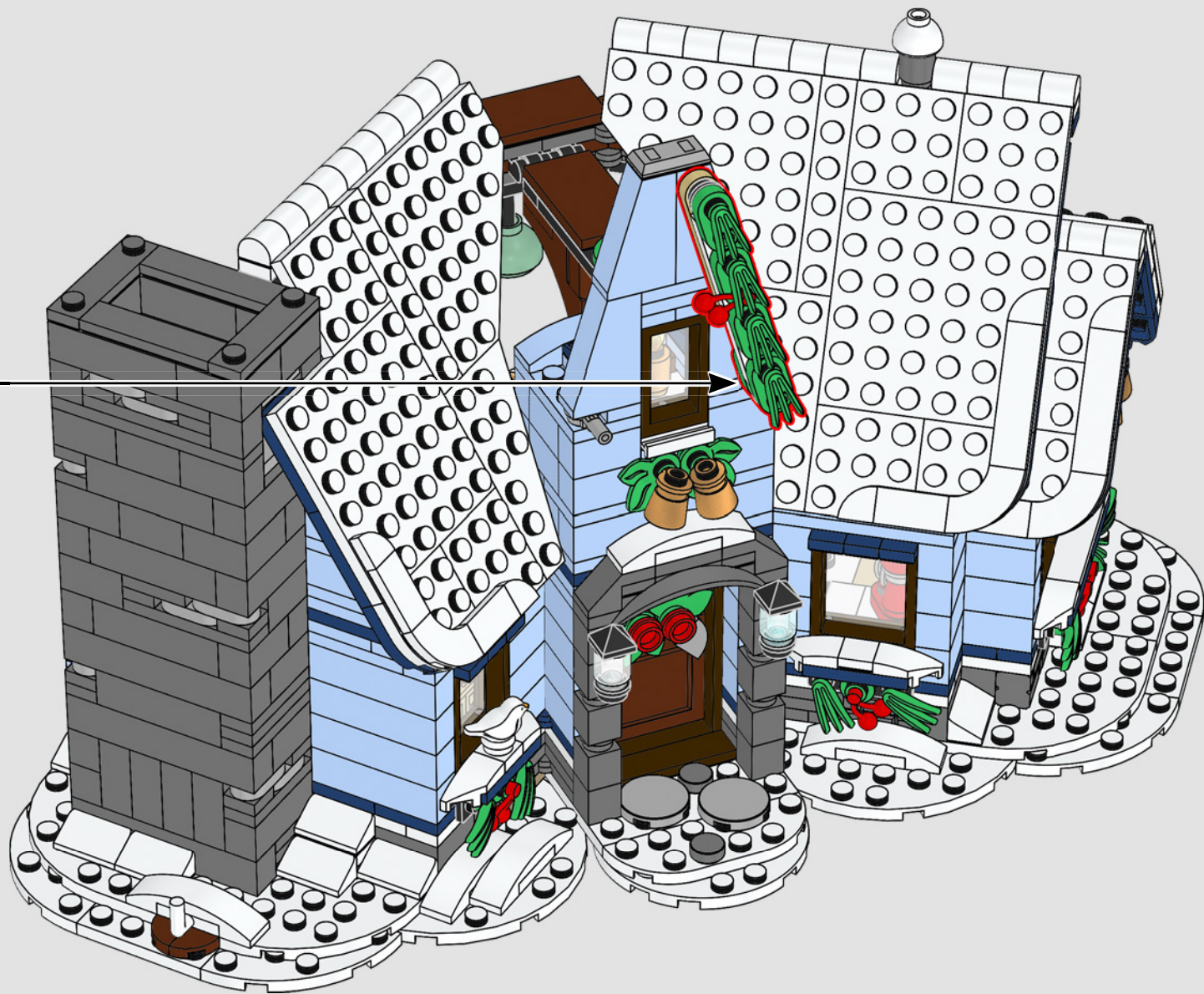

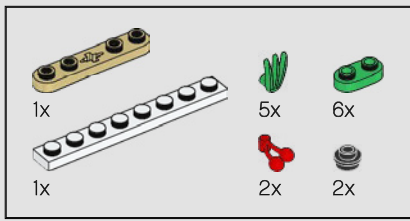

188

1

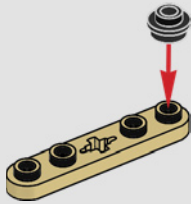

2

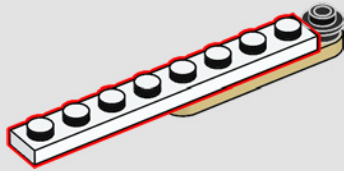

3

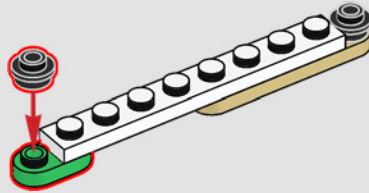

4

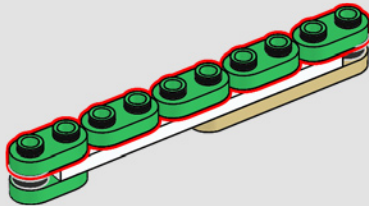

5

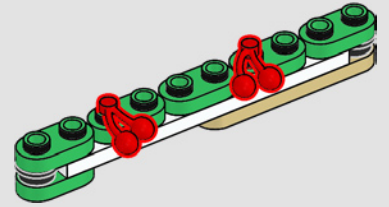

6

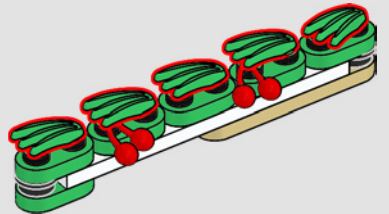



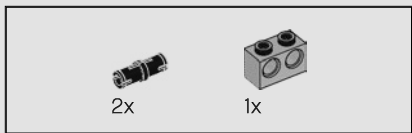

194

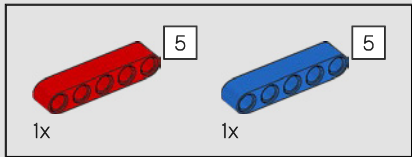
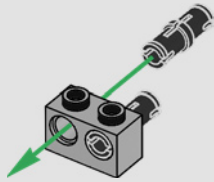
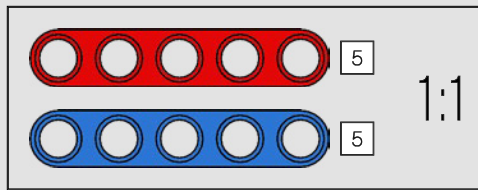

195

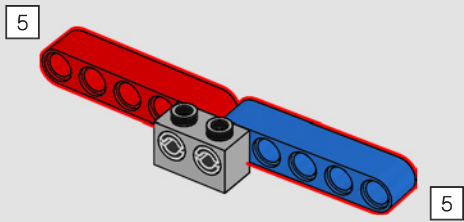

196

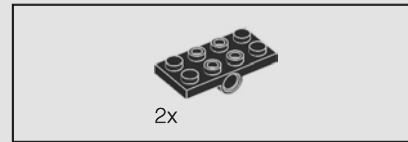
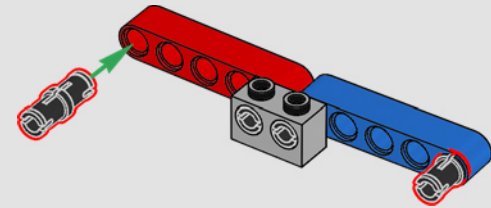

197

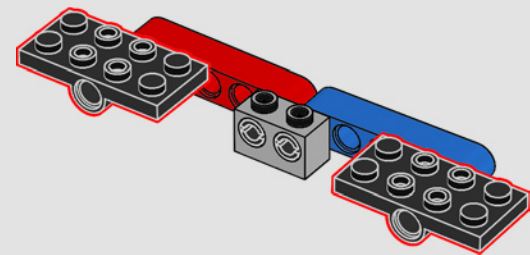



198

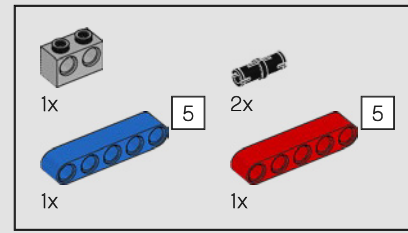
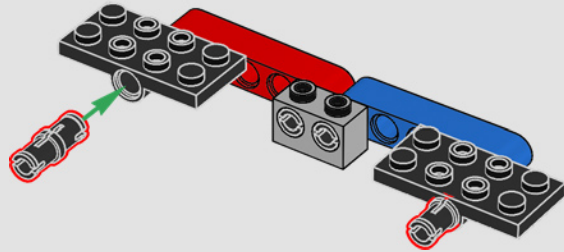

199

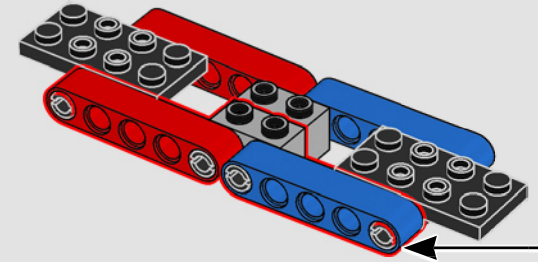
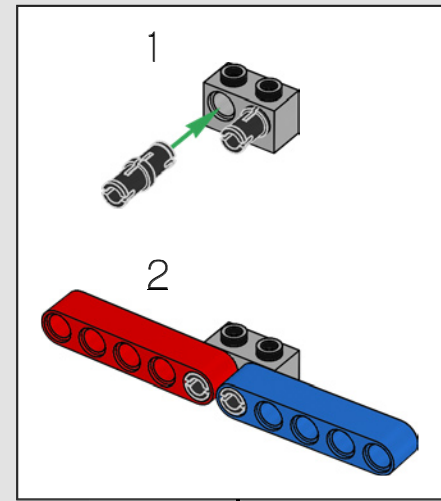

200

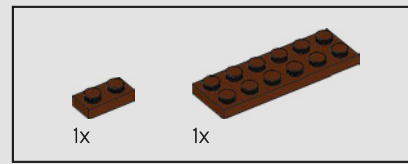
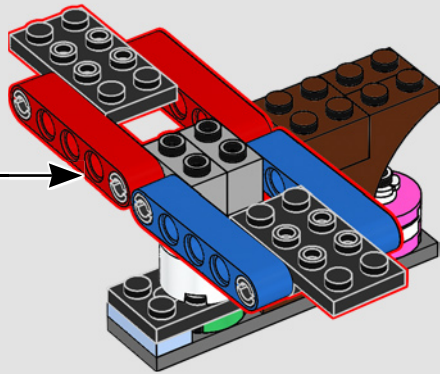

201

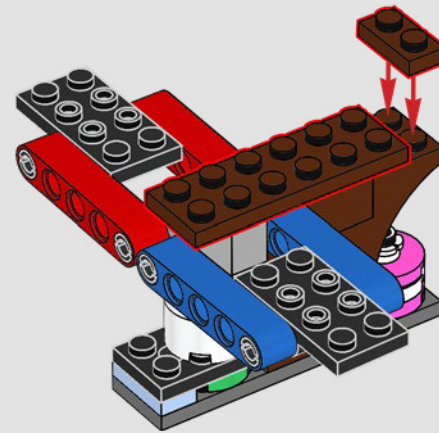



202

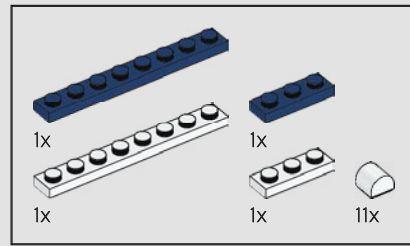
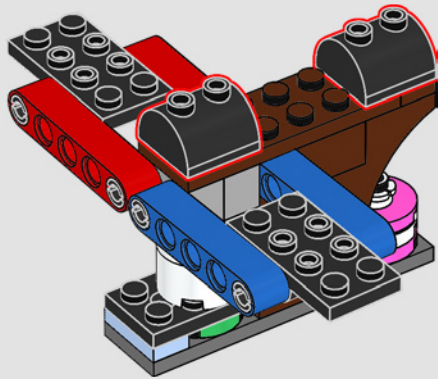

203

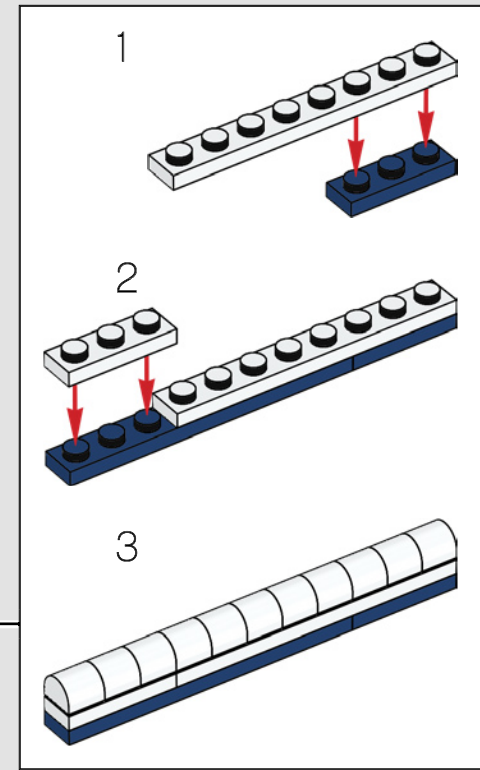
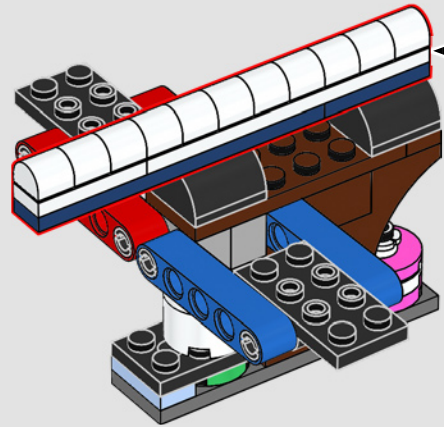

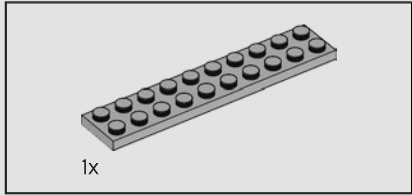
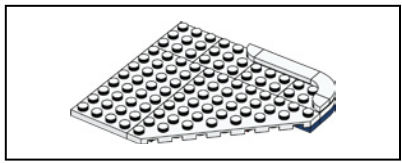

1x

204

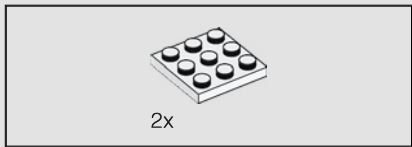
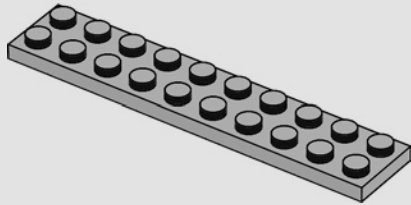

2x

205

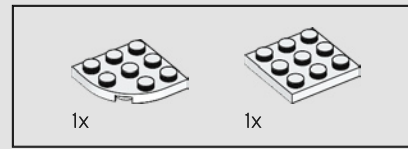
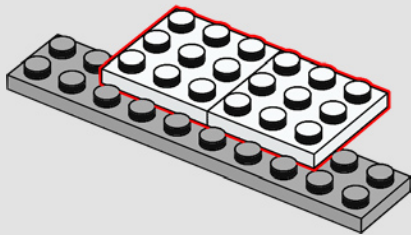

1x

1x

206

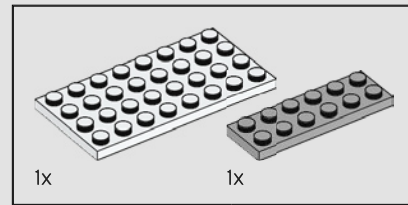
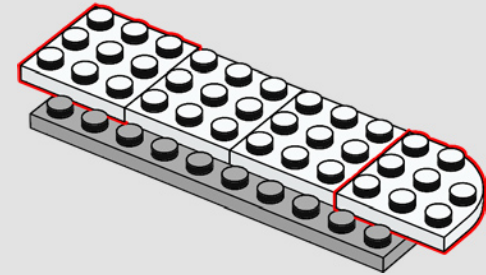

1x

1x

207

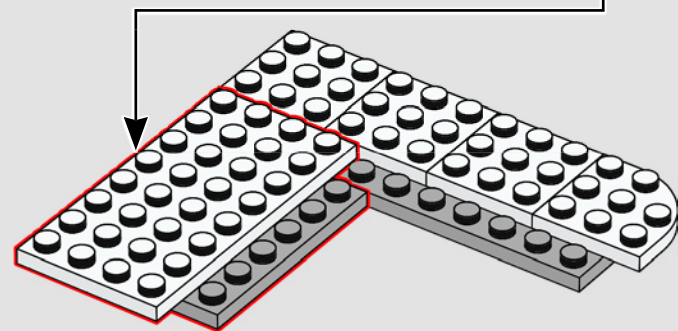
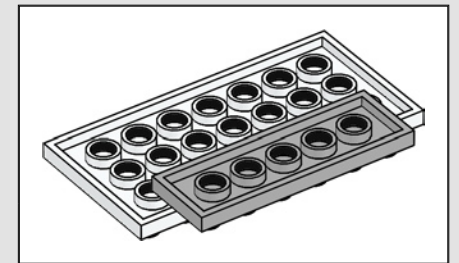

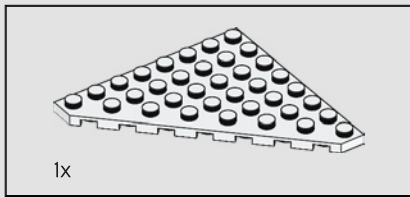

208

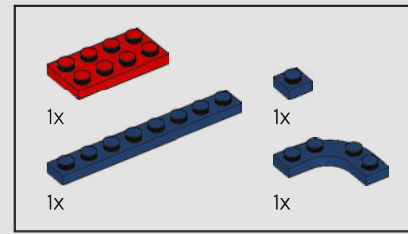
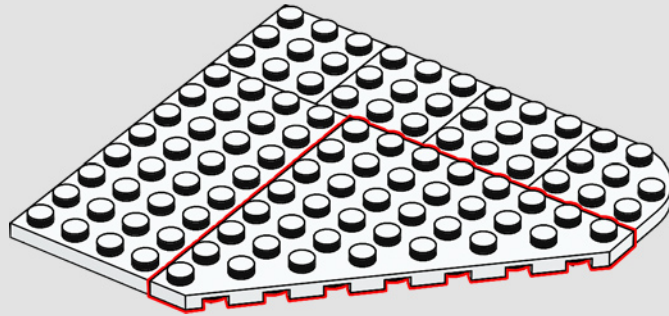

209

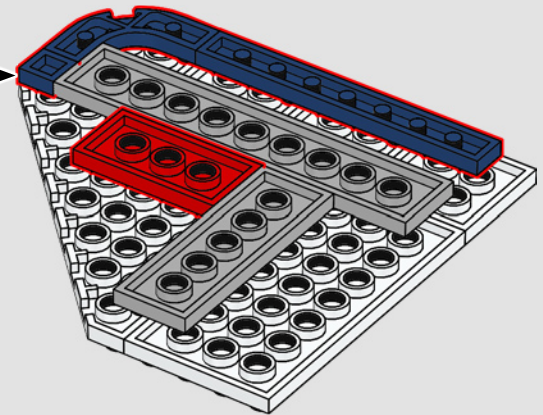
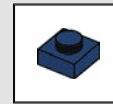
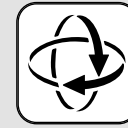

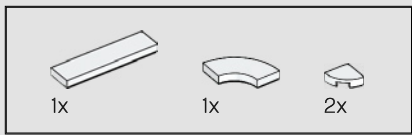

210

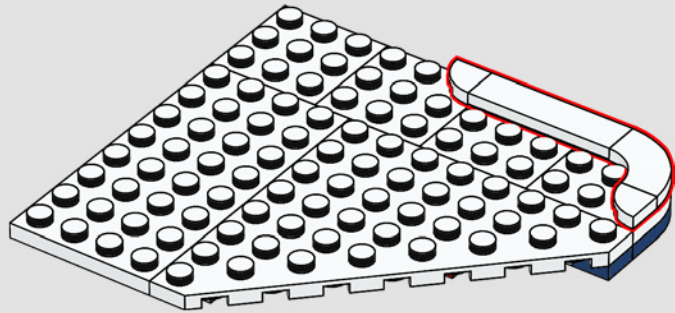

211

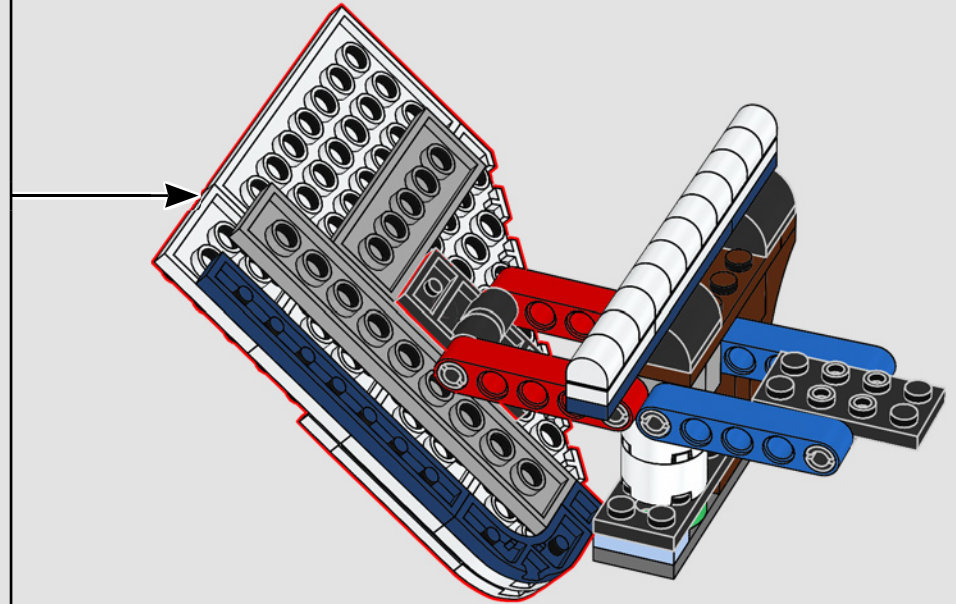

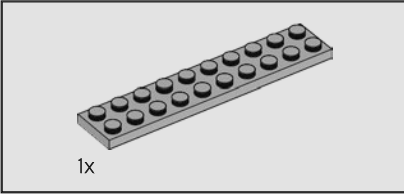
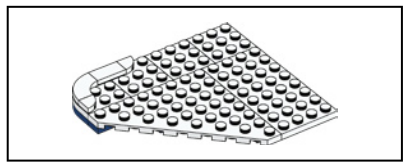

212

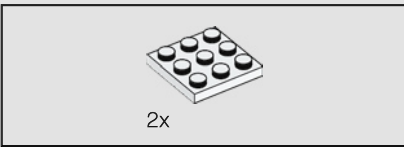
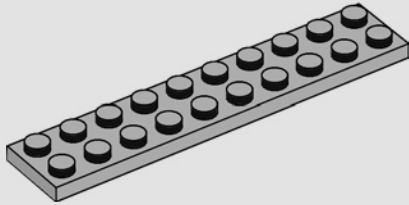

213

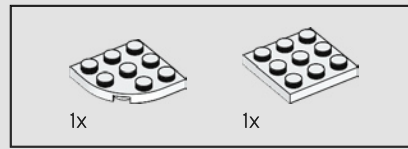
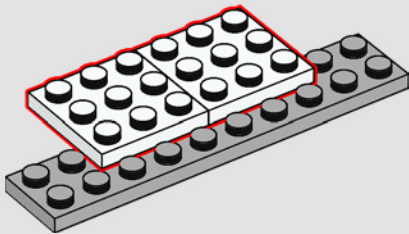

214

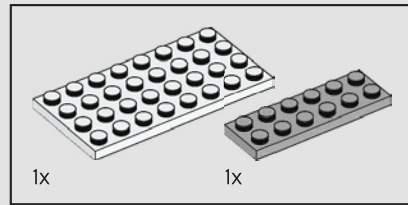
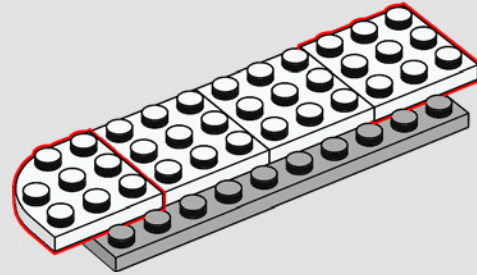

215

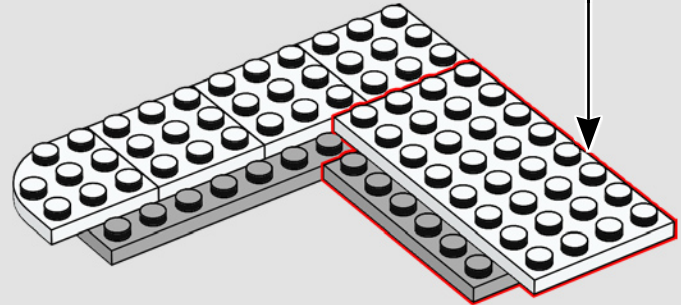
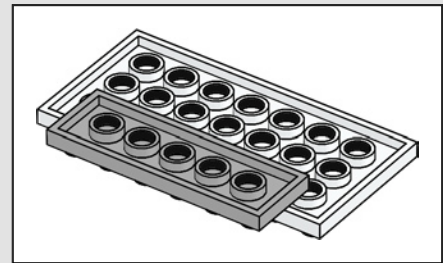

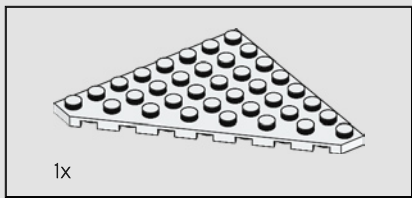

216

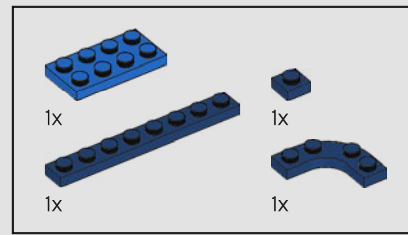
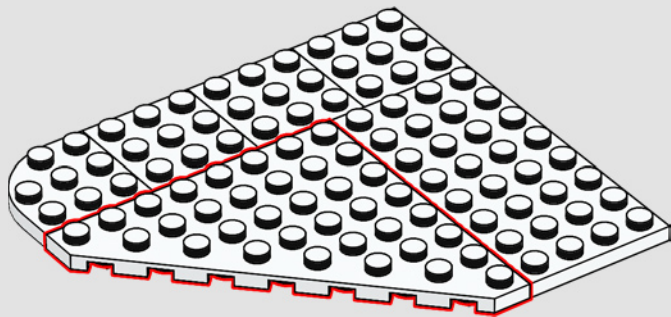

217

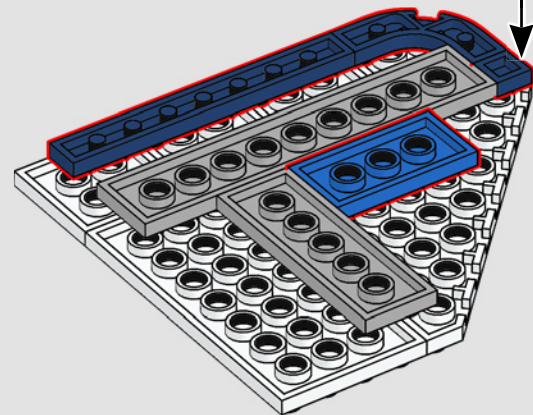
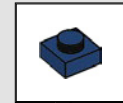

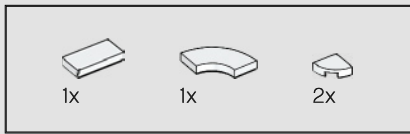

218

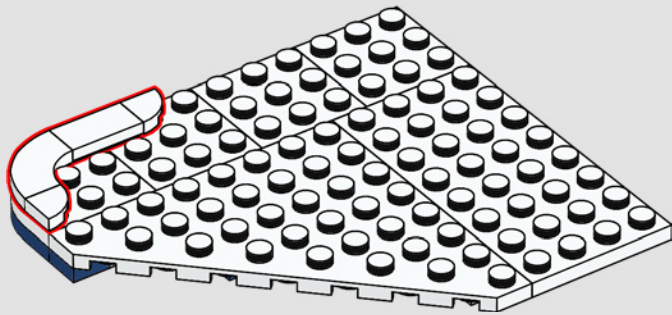

219

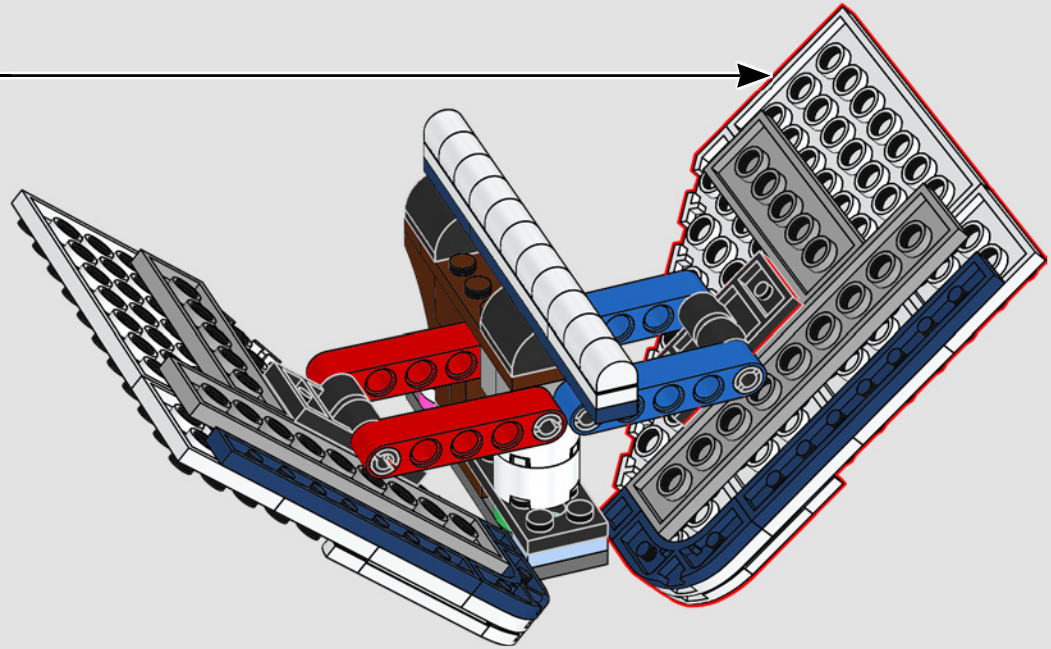

220

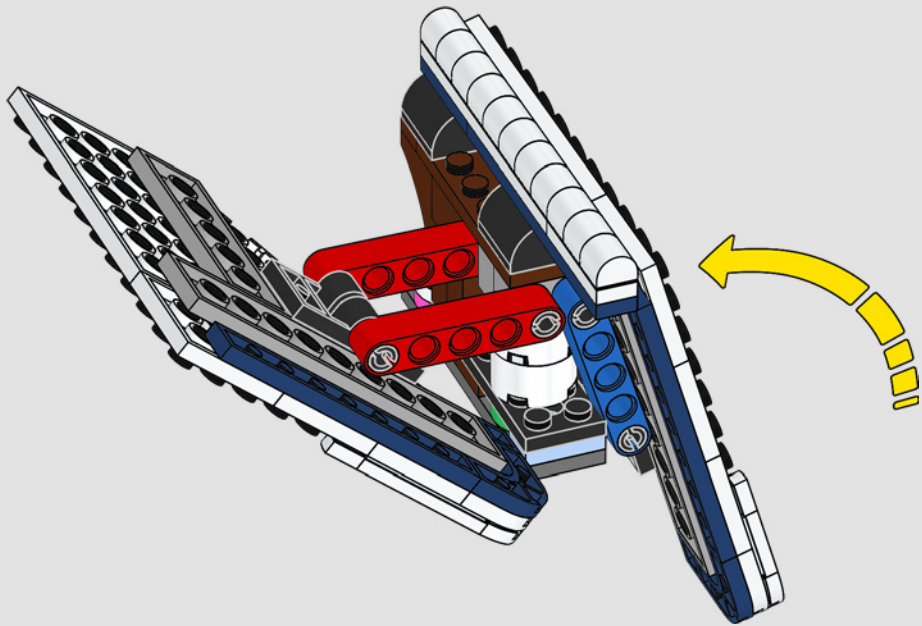

221

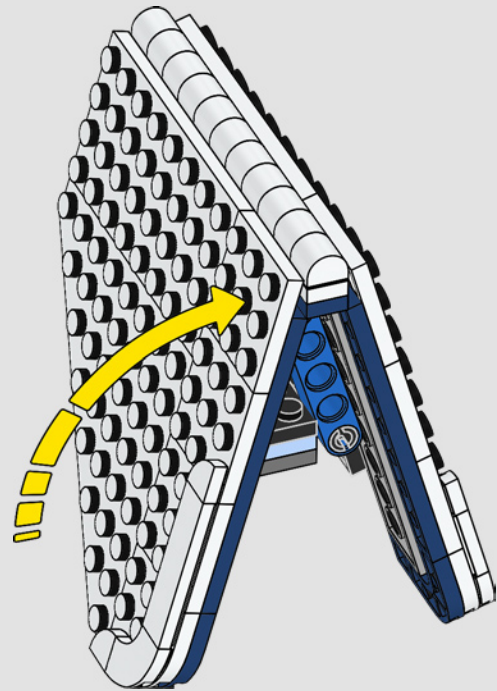

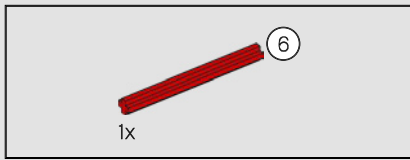

222

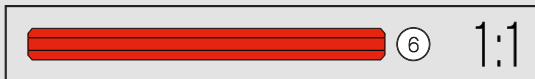
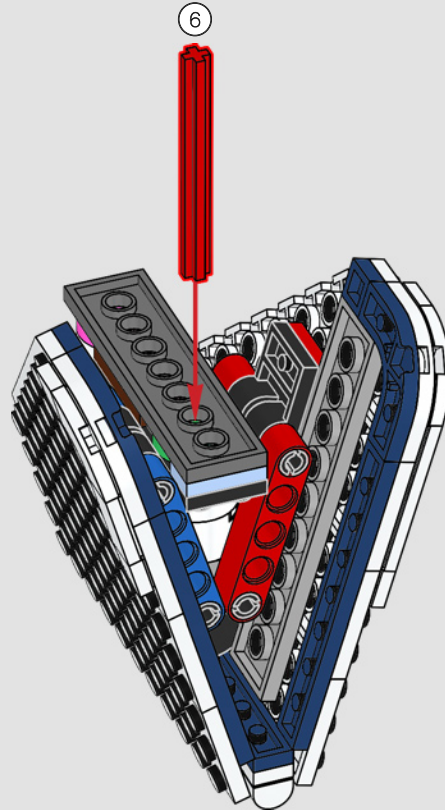

223

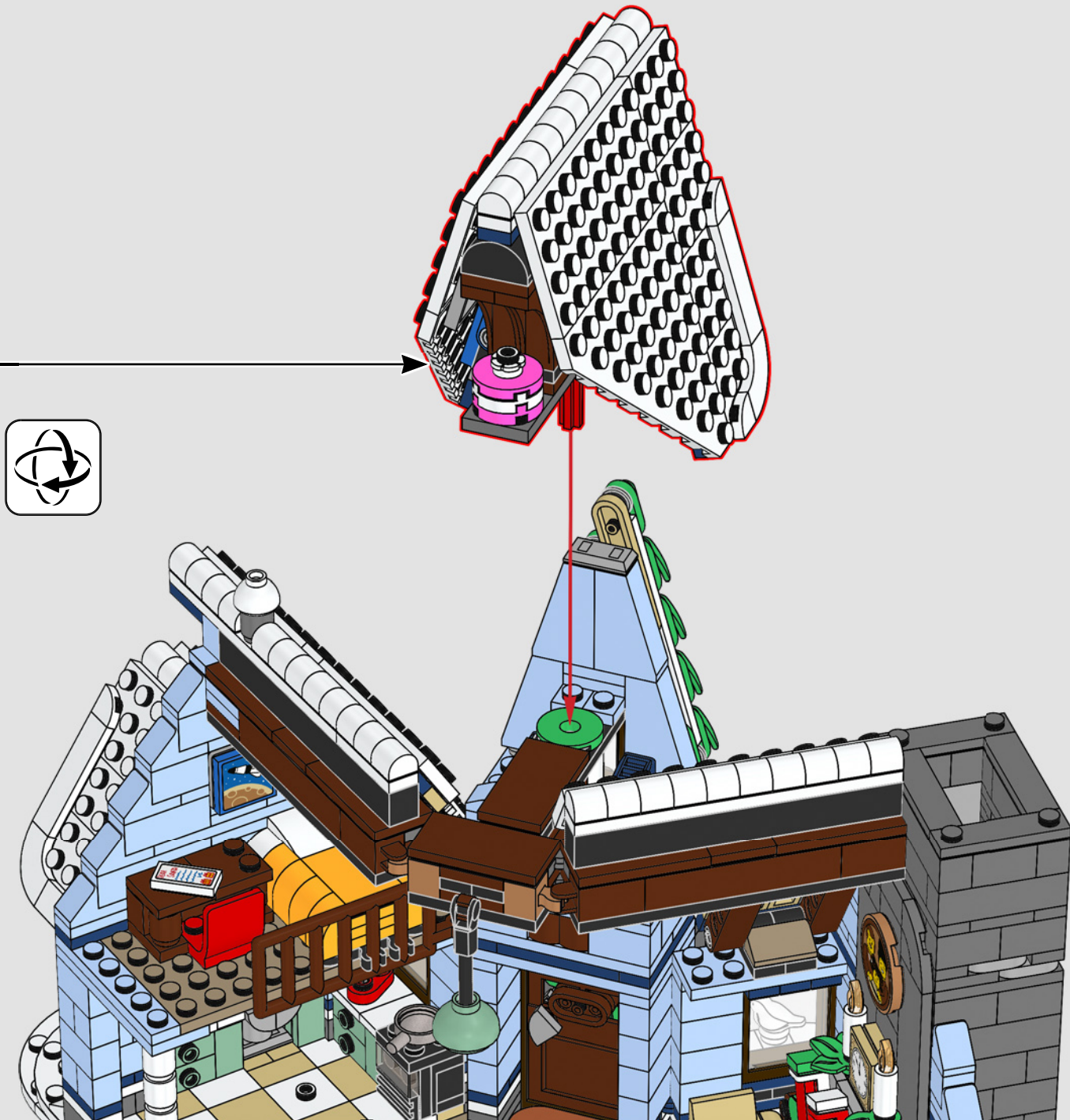

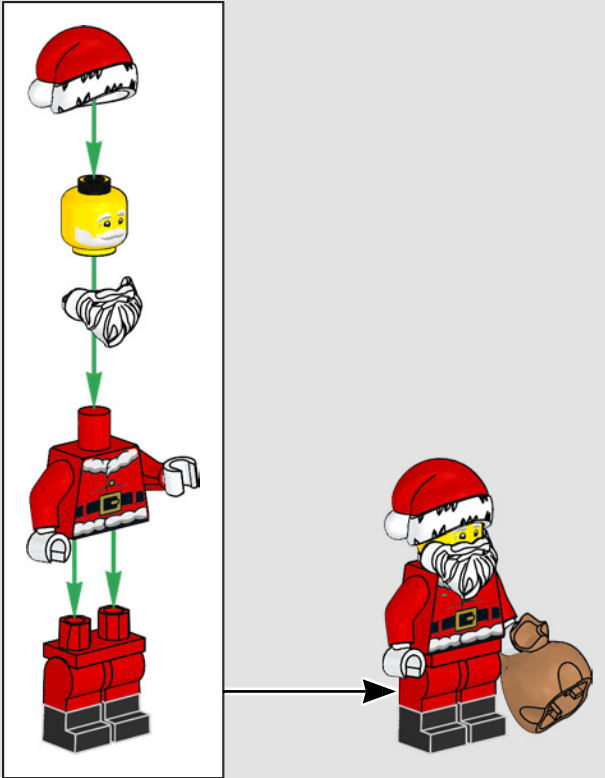

Die Weihnachtsmann-Minifigur wurde für dieses Set überarbeitet. Das Gesicht und der Oberkörper sind neu bedruckt und seine Beine stecken zum ersten Mal in großen schwarzen Stiefeln!

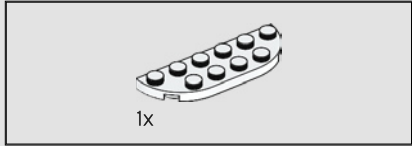
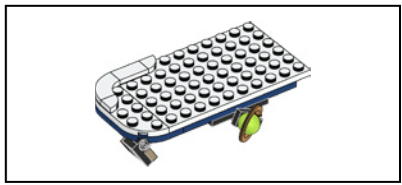

224

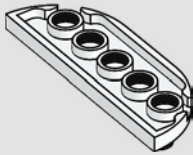

225

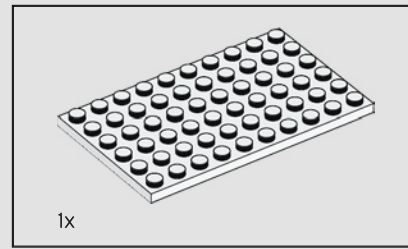
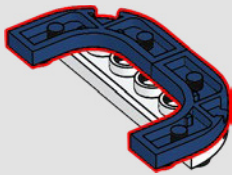

226

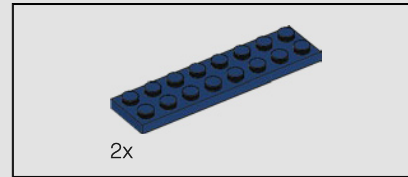
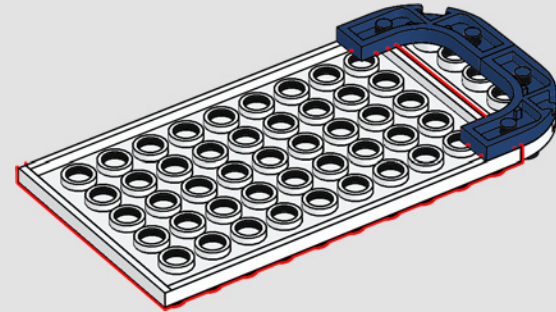

227

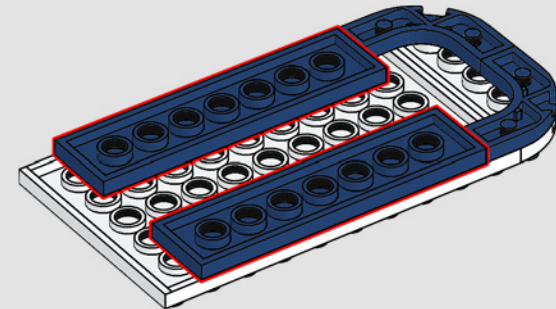

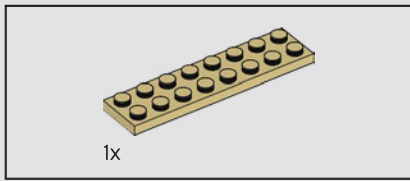

228

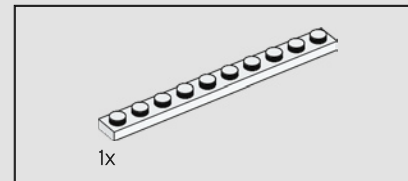
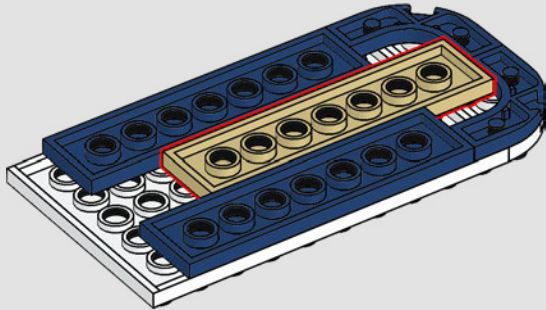

229

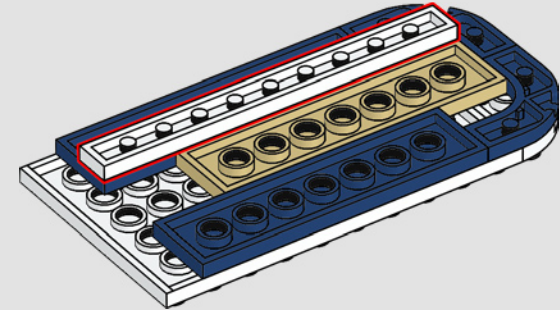

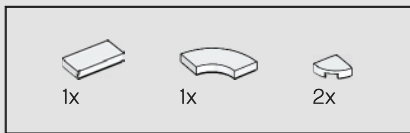

231

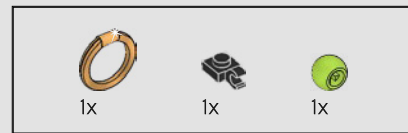
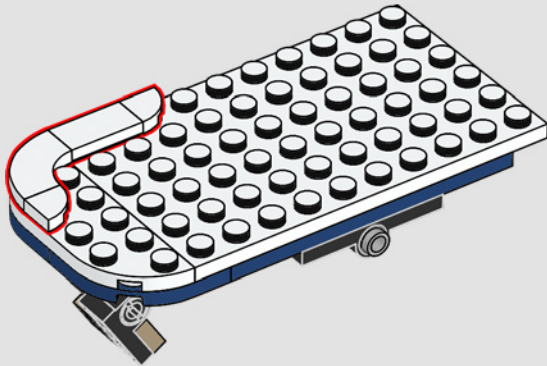

232

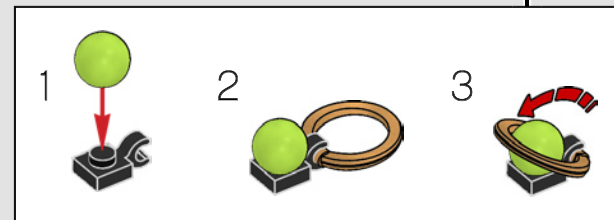
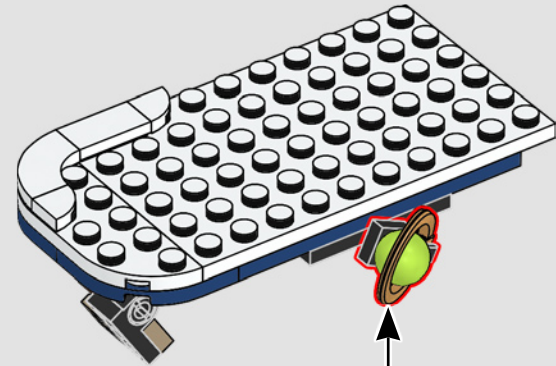

Das Dach über dem Zimmer des kleinen Mädchens lässt sich zum Spielen aufklappen.

233

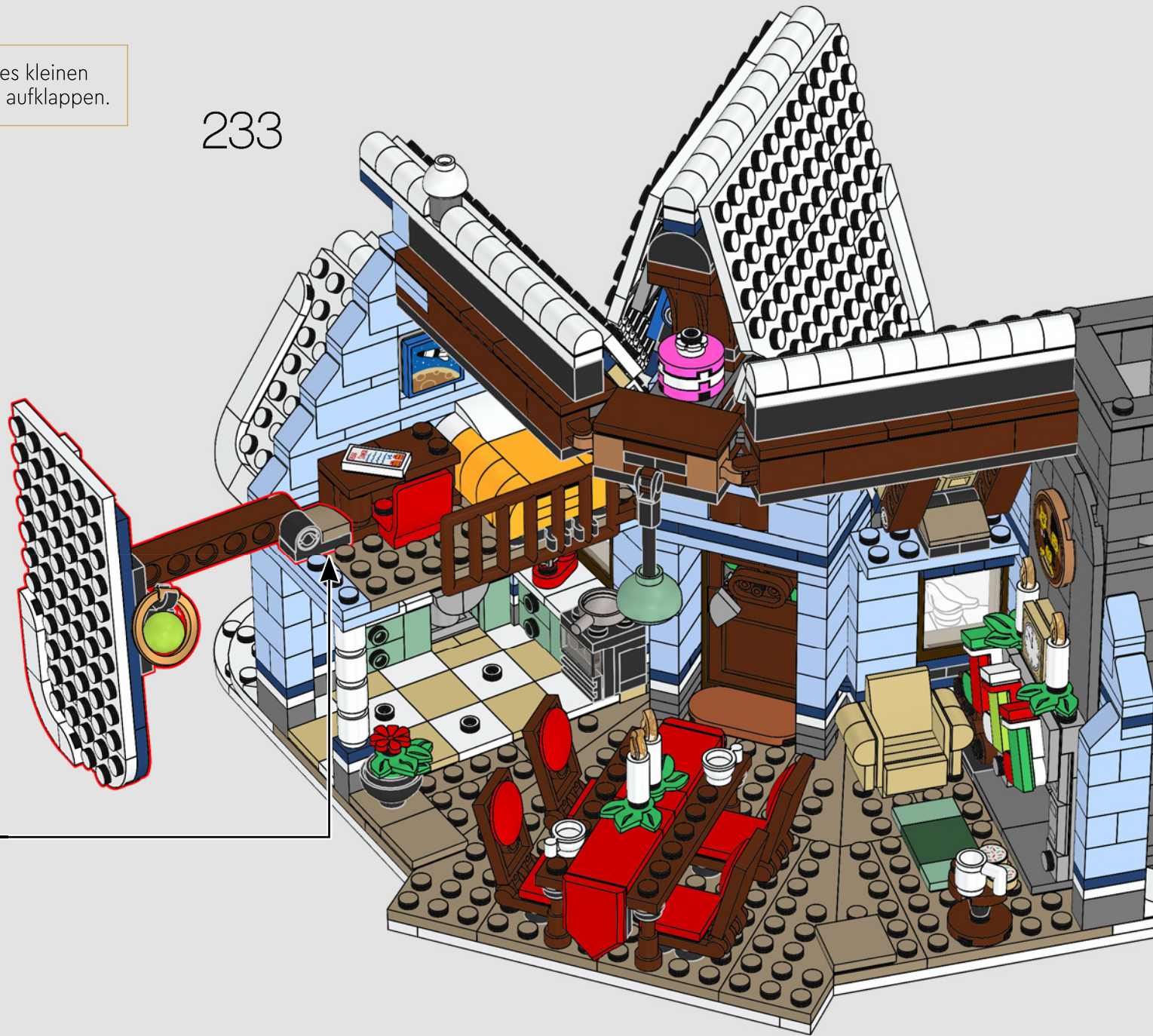

234



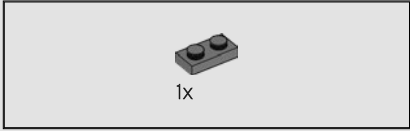
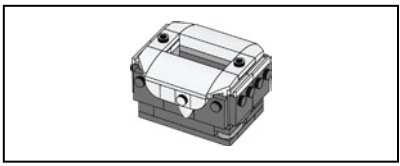

235

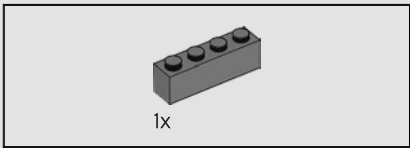
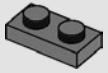

236

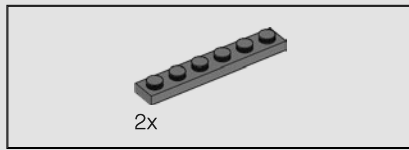
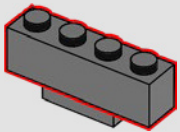

237

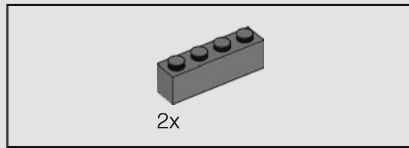
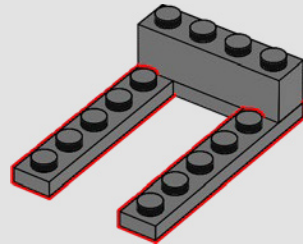

238

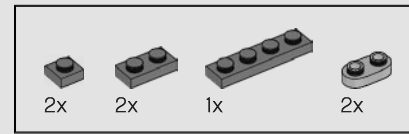
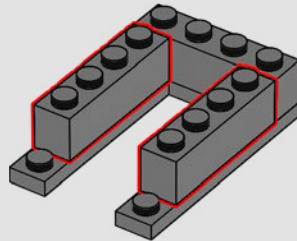

239

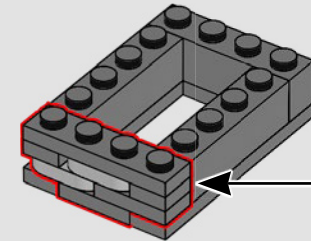
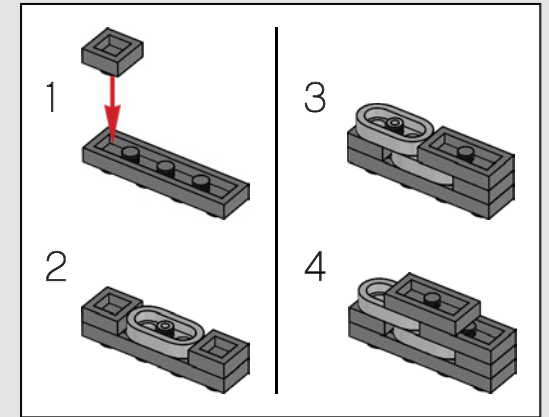



240

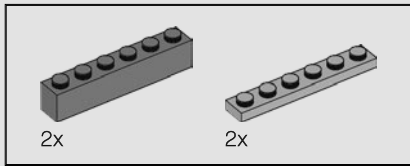
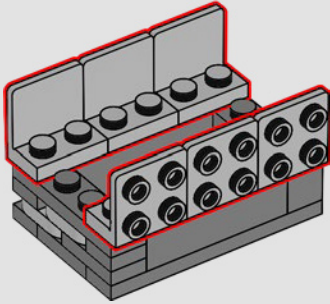

241

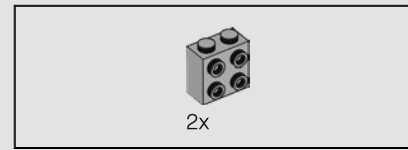
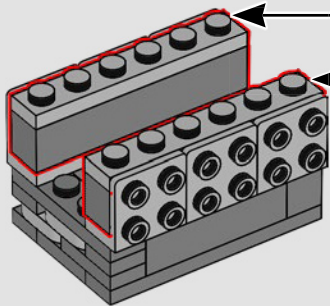
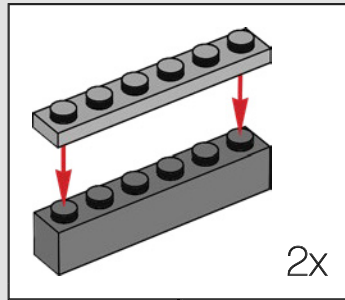

242

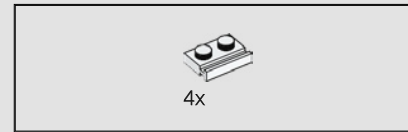
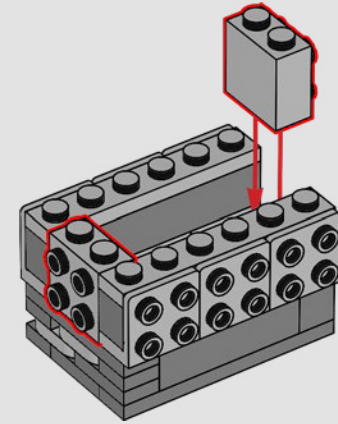

243

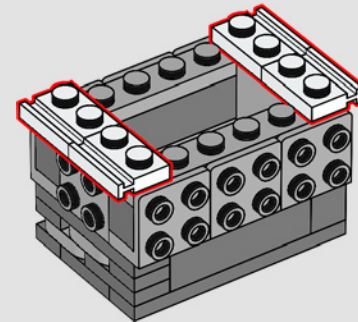

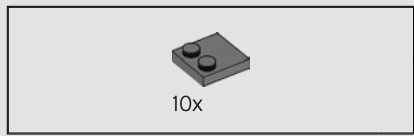

244

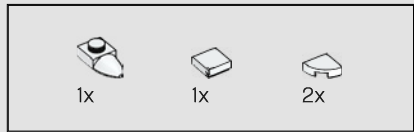
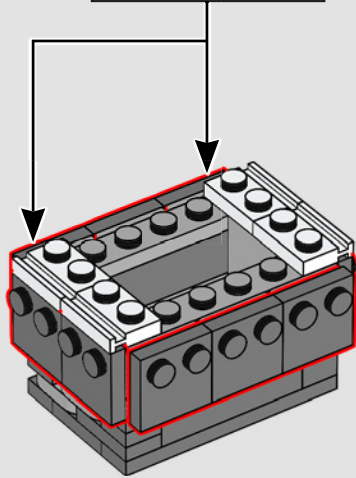
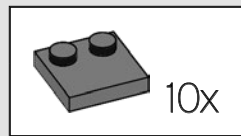

245

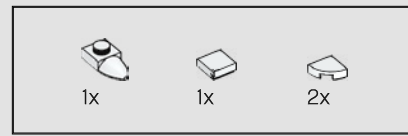
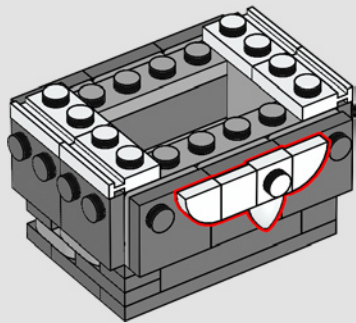

246

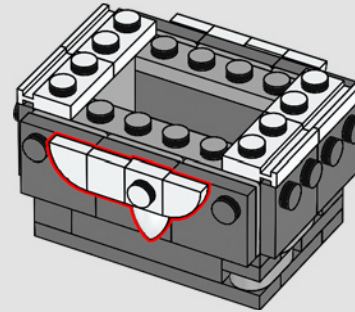
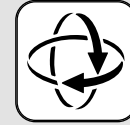

247

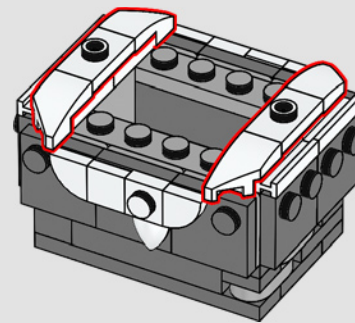

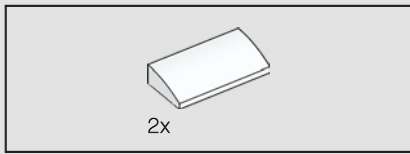

248

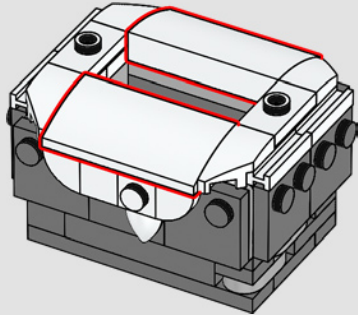

249



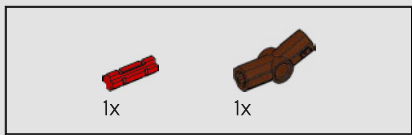

250

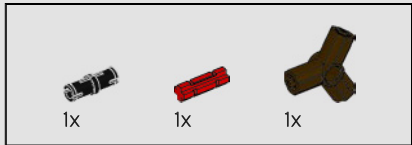

251

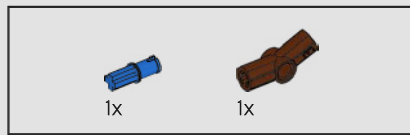
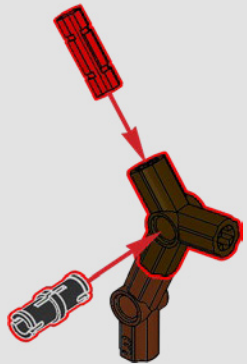

252

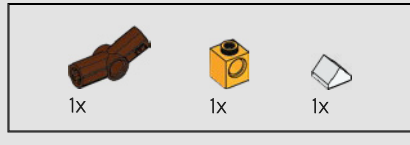
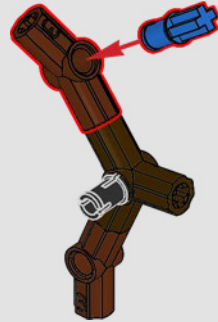

253

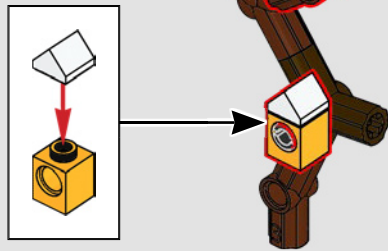

254

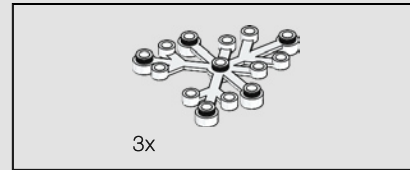
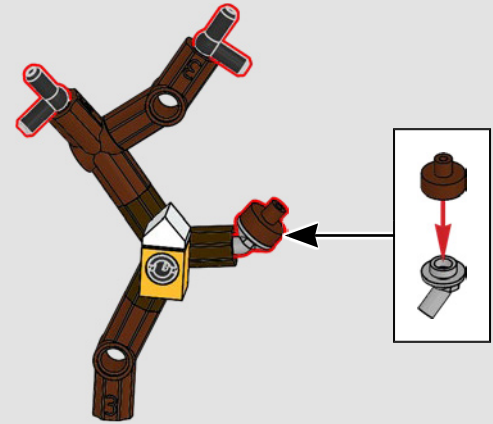

255

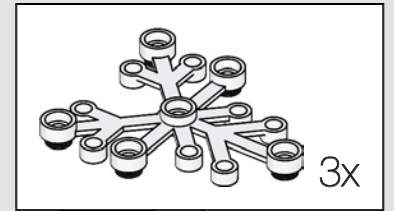
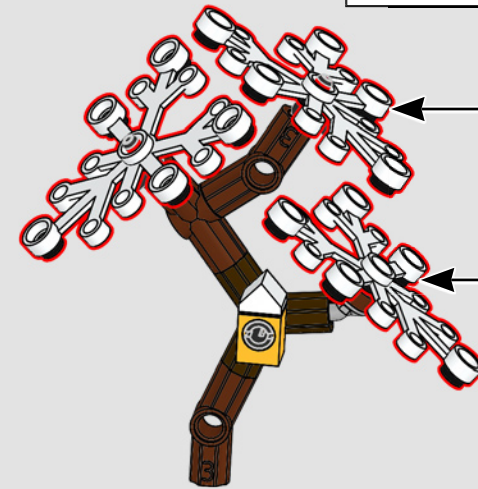

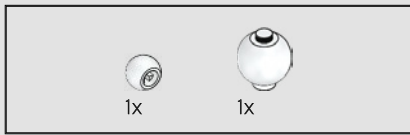

256

Zum ersten Mal beinhaltet jetzt ein Set aus der Winter-Sammlung einen Laubbaum. Der schwere Schnee auf seinen nackten Ästen trägt zur Winterstimmung bei.

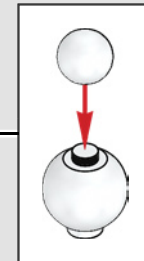
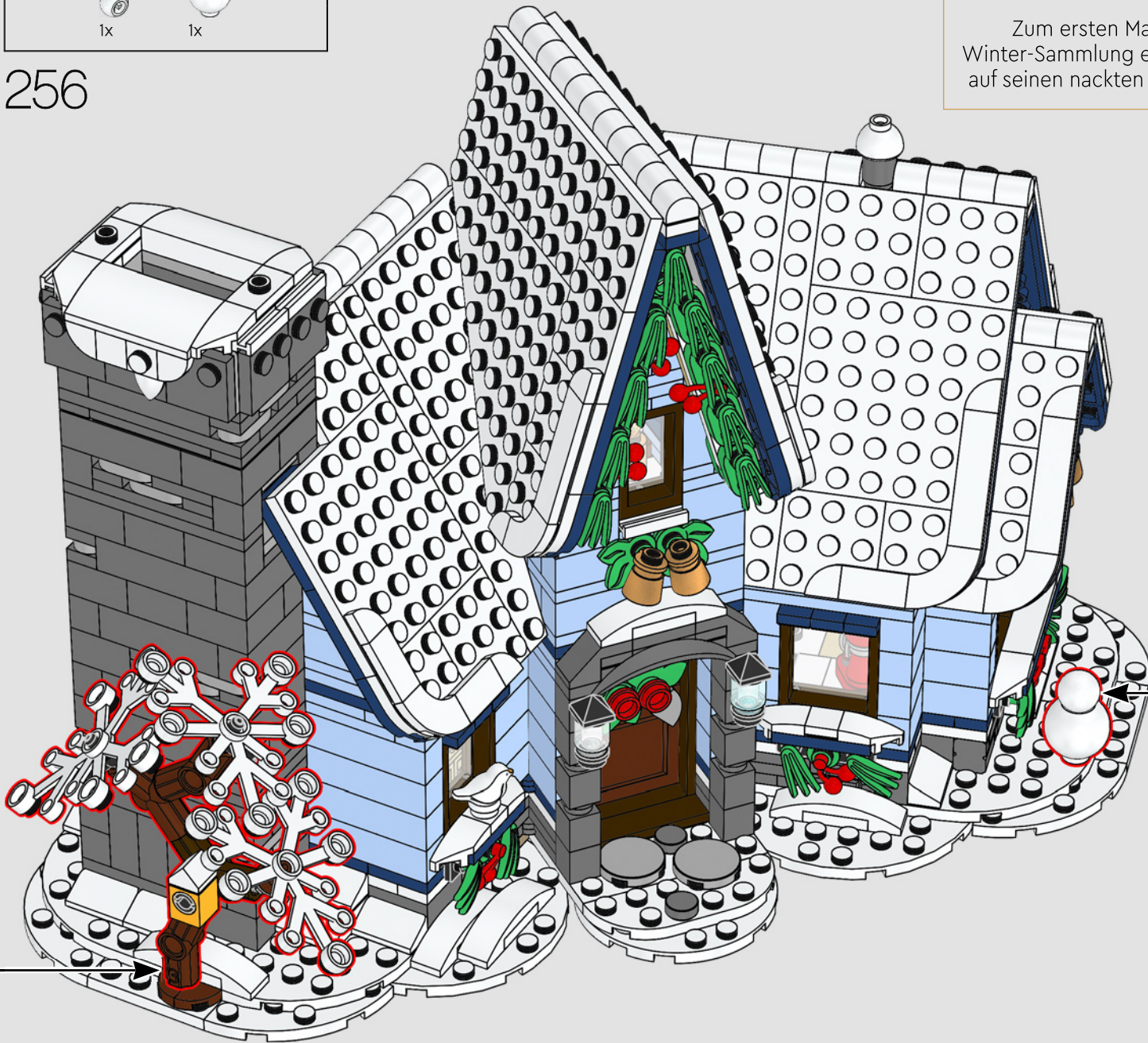

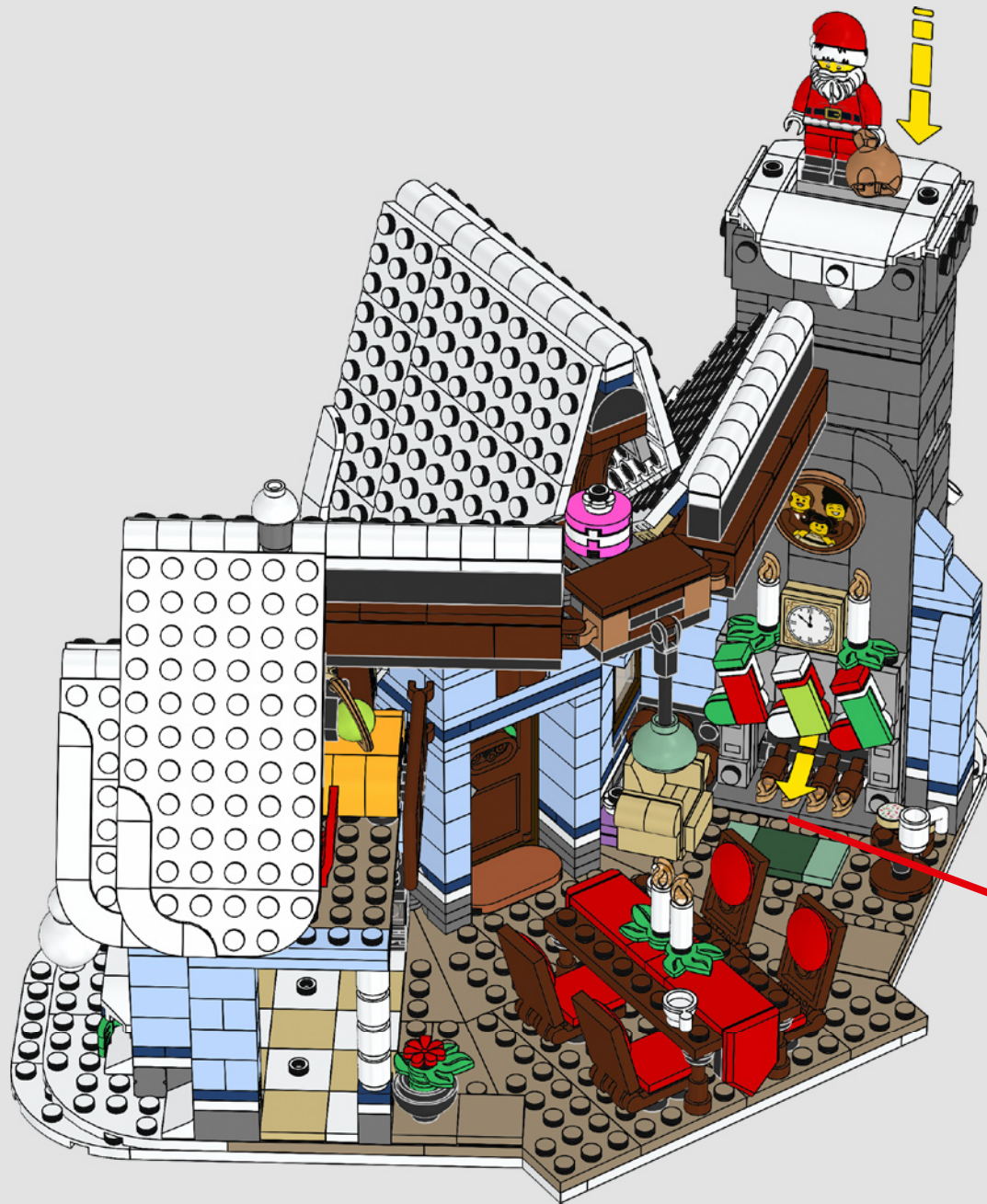

Der Weihnachtsmann kann den Schornstein hinunterrutschen, das brennende Holz umstoßen und ins Wohnzimmer purzeln.





Sollte der Weihnachtsmann im Kamin stecken bleiben, lässt sich die Spitze des Schornsteins abnehmen!



FEEDBACK AND WIN



FEEDBACK AND WIN

Your feedback will help shape the future development of this product series.

Please visit:

FEEDBACK UND GEWINNEN

Dein Feedback trägt zur Weiterentwicklung dieser Produktreihe bei.

Geh auf:

COMMENTEZ ET GAGNEZ

Vos commentaires nous aideront à concevoir les futurs produits de cette gamme.

Rendez-vous sur :

COMENTA Y GANA

Tu opinión nos ayudará a dar forma al desarrollo de esta serie de productos en el futuro.

Visita:

反馈有奖

您的反馈将有助于我们在今后改进本系列产品。

请访问：

[LEGO.com/productfeedback](https://www.lego.com/productfeedback)

By completing, you will automatically enter a drawing to win a LEGO® set.

Terms & Conditions apply.

Durch Ausfüllen nimmst du automatisch an der Verlosung eines LEGO® Preises teil.

Es gelten die Teilnahmebedingungen.

En envoyant vos commentaires, vous serez automatiquement inscrit(e) à un tirage au sort qui vous permettra de remporter un prix LEGO®.

Offre soumise à conditions.

Al contestar, participarás automáticamente en el sorteo y podrás ganar un set LEGO®.

Sujeto a Términos y Condiciones.

完成我们的反馈调查，即可自动进入抽奖环节，赢取乐高®套装。

适用《条款和条件》。

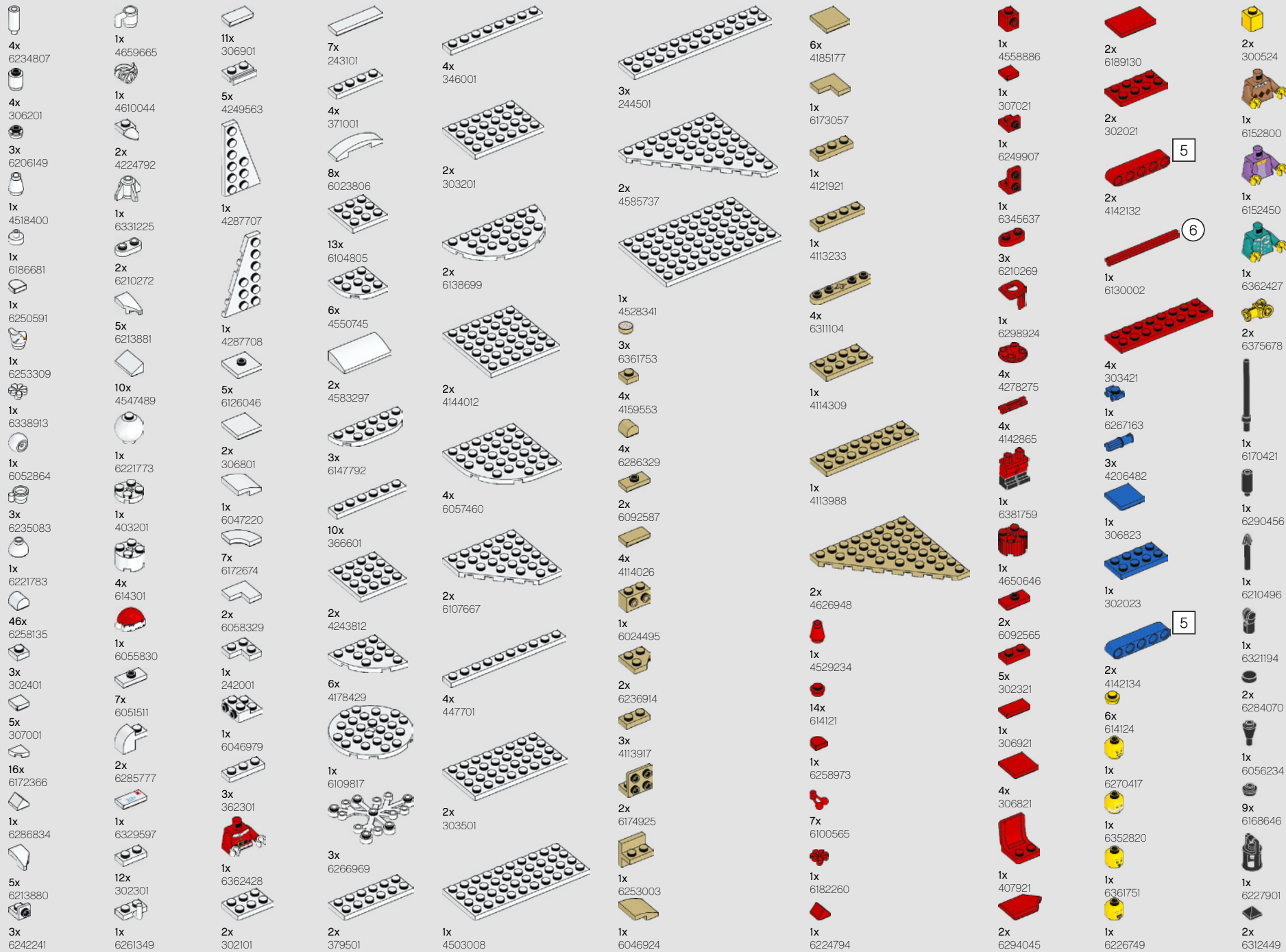

2x 6299338	3x 6117973	2x 611126	2x 306928	1x 6322126	2x 6015449	8x 4184108	1x 6251292	1x 4504376	2x 4216695
1x 6308000	1x 6310268	2x 611126	8x 6226931	4x 4157103	1x 6021969	2x 6199890	1x 4624381	2x 6062574	1x 6196221
2x 6104209	1x 6093525	2x 383226	4x 302328	1x 6240515	1x 6028018	1x 4162916	1x 4220634	1x 6123038	2x 4211210
10x 6210270	1x 6093525	17x 6329651	4x 4121969	3x 6328131	1x 6028018	6x 6092588	1x 4500125	1x 6248944	2x 4211210
3x 6196548	2x 302226	1x 4529239	8x 6297286	1x 6258323	1x 6028022	2x 6251248	9x 6357747	1x 6248944	4x 6221608
2x 6330189	2x 4200023	6x 6338221	8x 4107637	5x 4616578	2x 4507045	7x 4528981	1x 6318085	1x 6102360	8x 6102975
1x 6269081	2x 4515368	1x 6250600	1x 6359041	1x 6258323	1x 6126075	3x 6363600	3x 6028736	3x 4211180	3x 6261388
1x 6102341	1x 6162892	1x 4558593	2x 6240030	4x 4616578	1x 6126075	4x 4528482	8x 6374487	1x 6172808	2x 6055086
19x 6279875	1x 302126	8x 4546705	4x 6244796	4x 6184432	4x 4550329	3x 4177735	1x 6286881	1x 6313124	1x 6103769
1x 6259045	1x 302026	4x 302428	4x 6252041	2x 6184348	2x 4530712	6x 4530028	1x 6097511	4x 6103004	2x 4211189
1x 9339	1x 302026	1x 6290602	1x 6184348	1x 6101254	2x 4530712	11x 4502089	4x 6341968	6x 4211150	2x 4211189
1x 300426	5x 6194233	11x 6210271	1x 6252258	4x 6101254	2x 4530712	8x 6361984	7x 4211183	4x 6310449	1x 4216668
1x 241226	1x 300126	13x 6229130	4x 6278710	3x 6002849	2x 6006524	2x 6135593	3x 6186673	2x 6234272	2x 6150305
5x 6114987	1x 300126	1x 6074954	20x 6240204	3x 6002849	2x 6006524	6x 6250216	10x 4211242	1x 6338135	1x 4211225
1x 302326	2x 6138405	1x 403228	2x 6251294	3x 6002851	1x 6096215	3x 6027627	2x 6149677	1x 4565394	4x 6348062
5x 6016172	2x 3200126	1x 6189162	2x 6239418	3x 6002851	1x 6096215	3x 6027627	2x 4221744	2x 4271949	

- 4x 6307618
- 2x 4579690
- 2x 6044725
- 2x 4221590
- 1x 6070442
- 1x 4243838
- 2x 4216615
- 1x 4211247
- 5x 6179614
- 1x 6030812
- 1x 4211207

- 1x 6247795
- 1x 6249246
- 1x 6326748
- 3x 4211525
- 2x 4211483
- 4x 6176433
- 1x 6262085
- 2x 4211399
- 12x 6248890
- 1x 6311384
- 2x 6227897
- 4x 6052200
- 1x 4593679
- 2x 4211541
- 6x 6134378
- 7x 6123809

- 8x 4654580
- 3x 6126082
- 4x 4211353
- 2x 4654577
- 6x 4211396
- 1x 6226541
- 1x 4211441
- 3x 4211445
- 2x 4211438
- 3x 4211452
- 3x 4211462
- 12x 6285271
- 23x 6361987

- 2x 6335524
- 2x 6361990
- 4x 6132424
- 4x 6136397
- 24x 6362254
- 40x 6100322
- 12x 6182777
- 3x 6361991
- 10x 6361988
- 16x 6287903
- 2x 6132418
- 6x 6361985
- 10x 6132422

- 1x 4211090
- 4x 6284596
- 4x 4210633
- 11x 4211098
- 23x 4210719
- 2x 6362259
- 4x 6199549
- 4x 6228923
- 20x 4211088
- 2x 6019987
- 1x 6092572
- 4x 6000311
- 2x 6168776
- 1x 6261355
- 1x 4211052
- 17x 4211063
- 1x 4543086

- 1x 4211094
- 10x 6309059
- 12x 4211109
- 2x 4210635
- 2x 6265306
- 5x 4211133
- 3x 4211104
- 4x 6172811
- 3x 6187008
- 13x 4211103
- 4x 6257592
- 11x 4211001
- 2x 4211053
- 12x 6102774
- 1x 6307616

- 1x 6362257
- 5x 4211100
- 1x 4620760
- 7x 4211056
- 2x 6321746
- 1x 4260707
- 2x 6252838
- 1x 6060800
- 1x 6190252
- 4x 6173139
- 1x 6034543
- 4x 6335111

- 1x 6286094
- 1x 6093529
- 1x 4528778
- 4x 6022105
- 1x 6259766
- 1x 6273219
- 4x 6331950
- 1x 6313874
- 1x 6337282

- 1x 6326495
- 1x 6223767
- 2x 6296061
- 2x 6360035
- 1x 6076674
- 1x 6218360
- 1x 6326106
- 1x 4624615
- 4x 6102986
- 2x 4619512
- 2x 6312455
- 3x 6363601

